

B-TYPE LONDON BUS



PAPER MODEL V1.1

Scale 1:32

Alan Grayer 2020
btype@grayer.me.uk

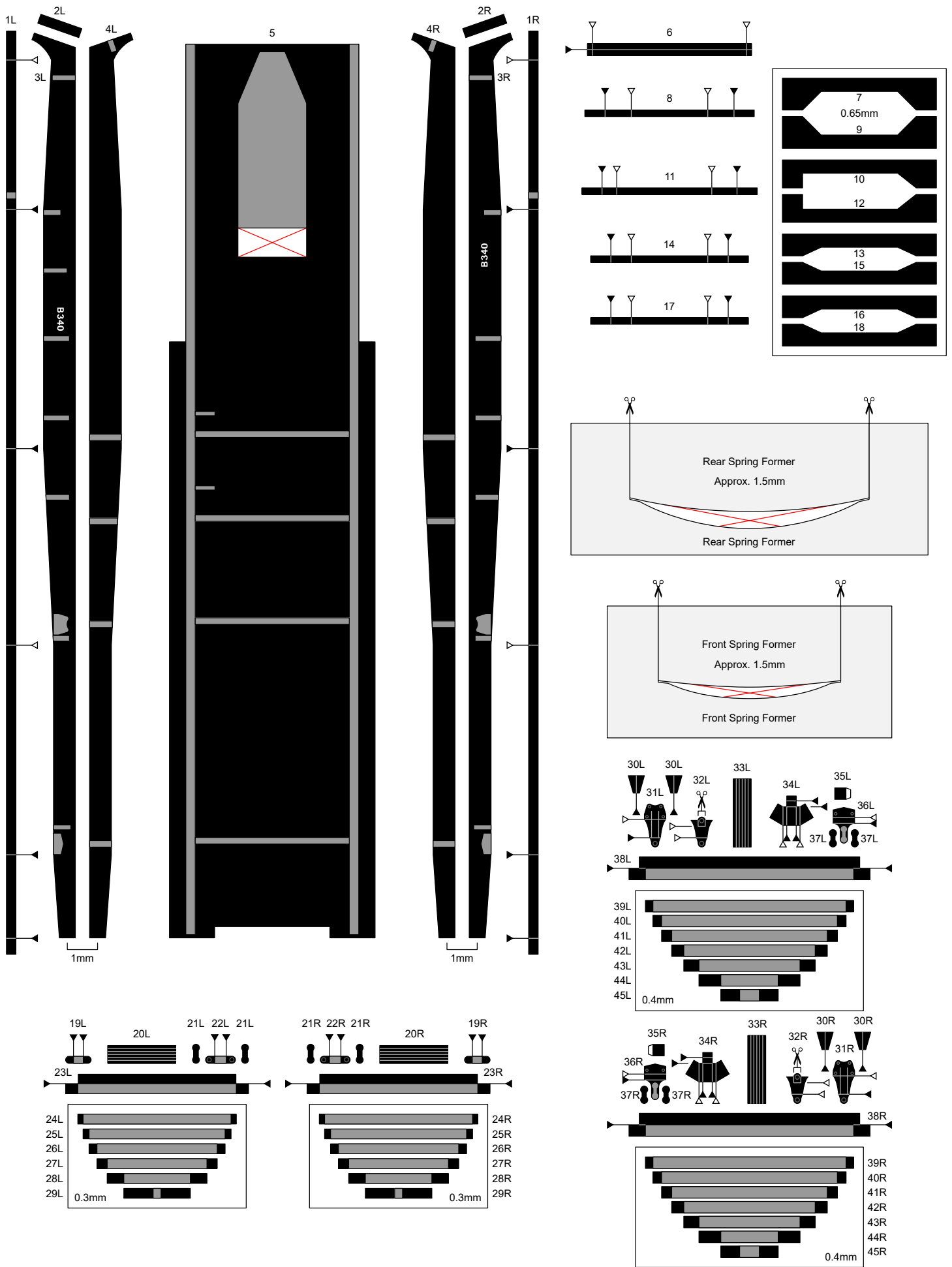

B-TYPE LONDON BUS 1:32
A: CHASSIS

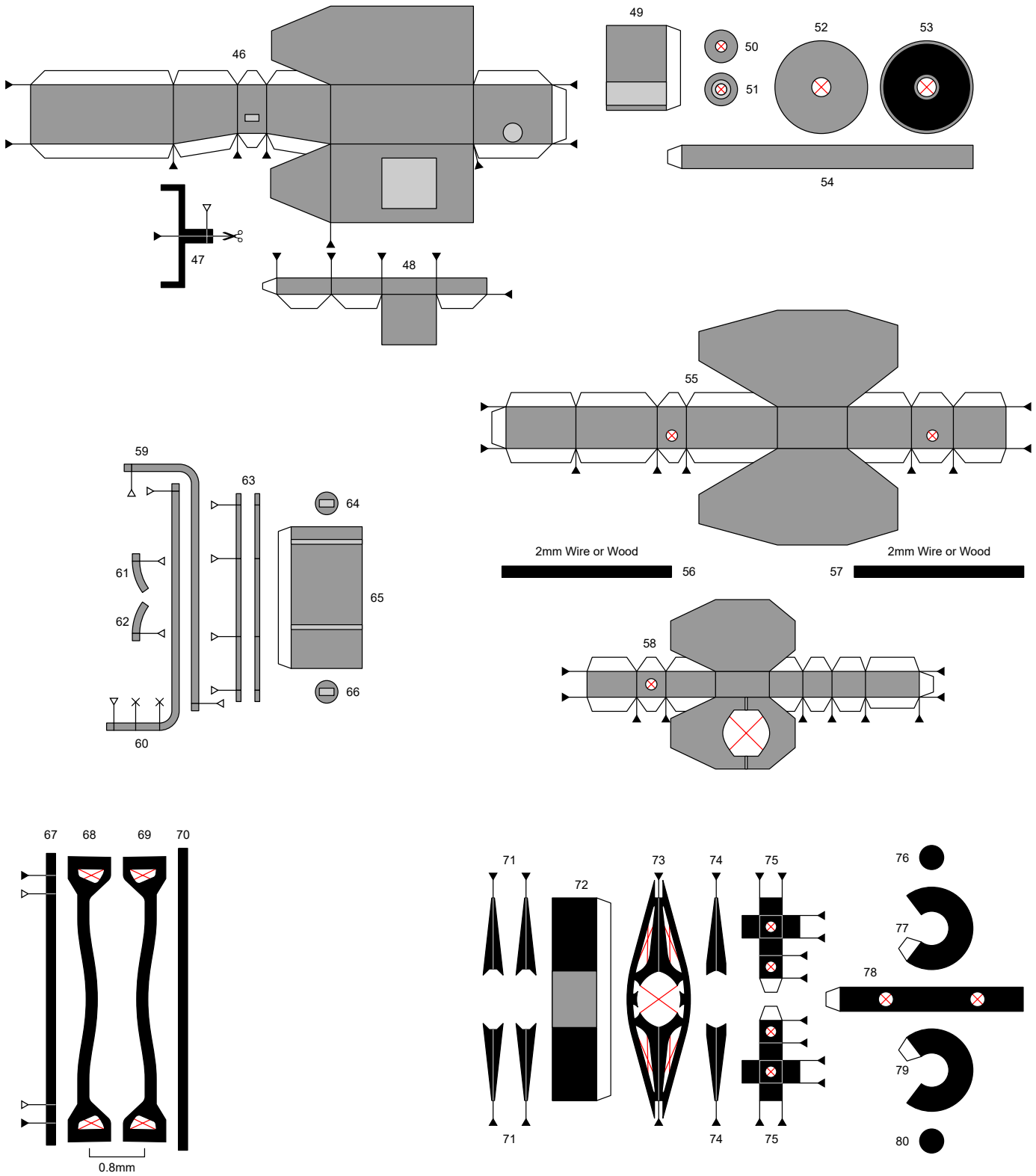

B-TYPE LONDON BUS 1:32
A: CHASSIS

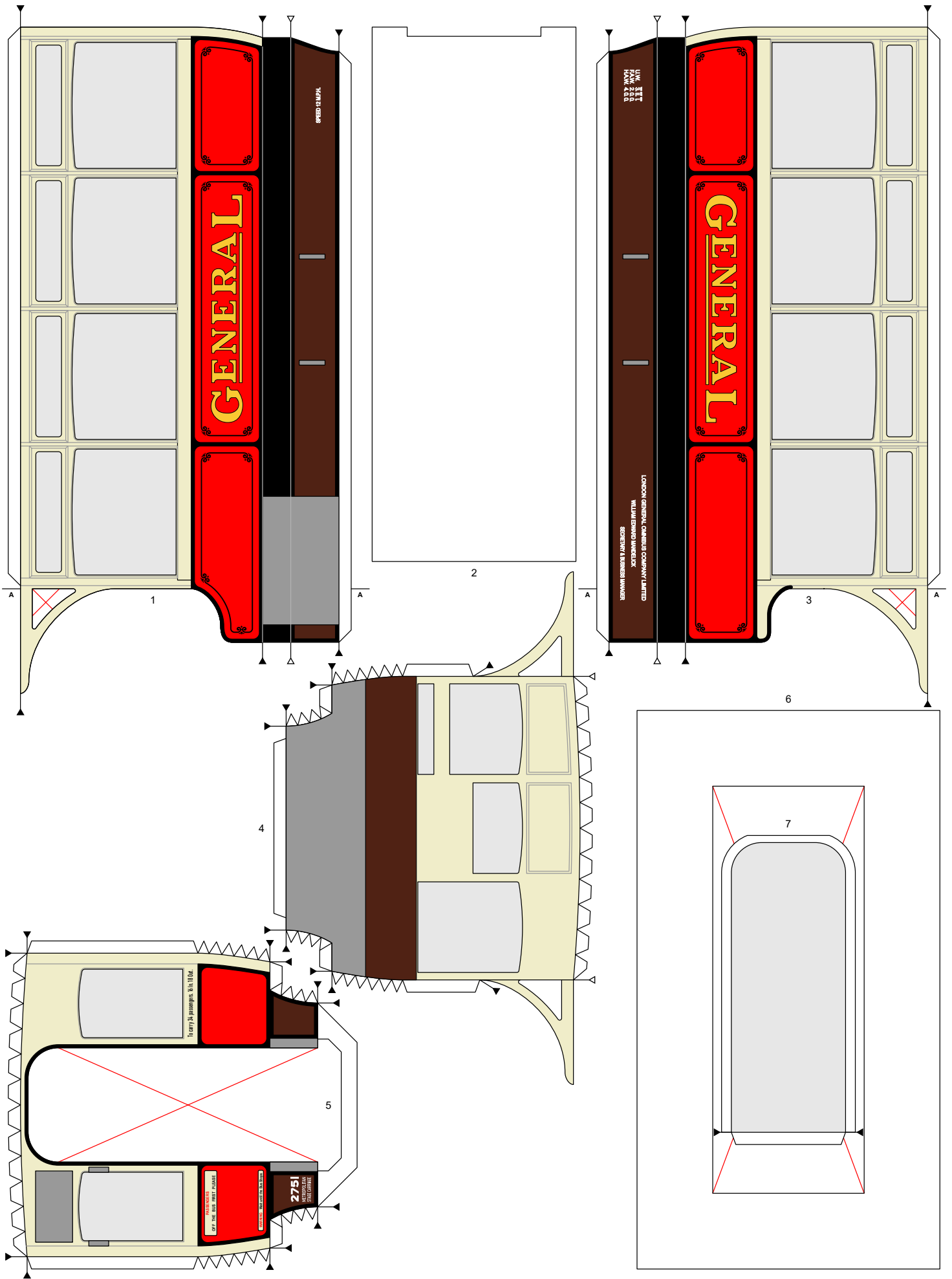

B-TYPE LONDON BUS 1:32
B: LOWER DECK SIMPLE - B1 -

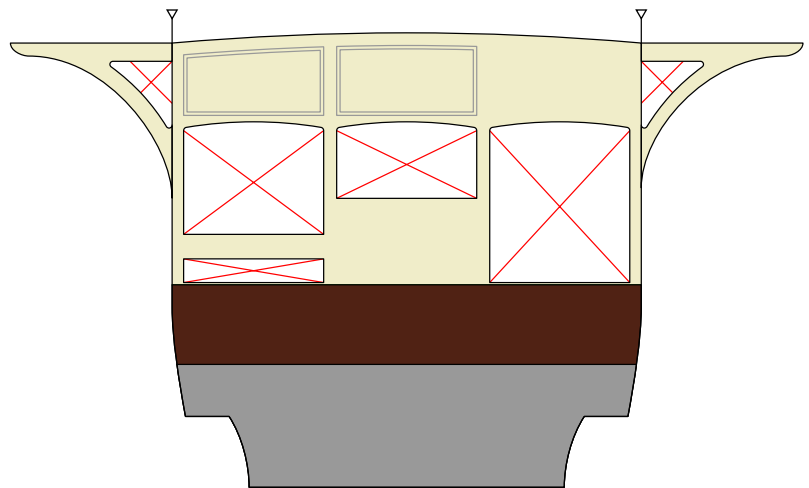
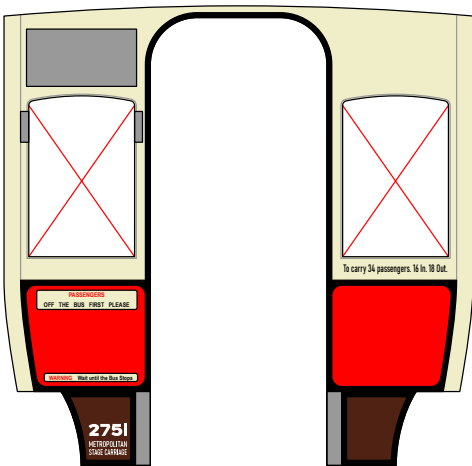
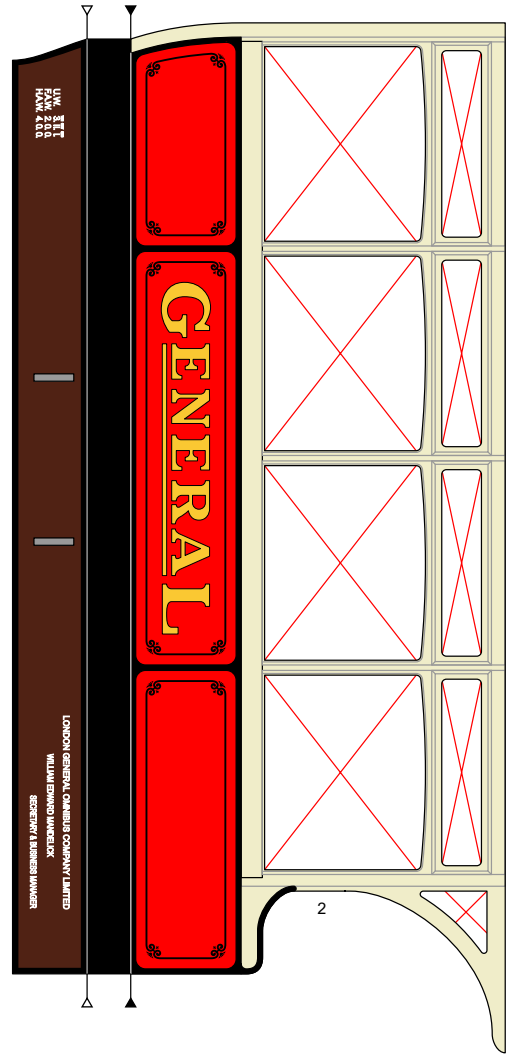
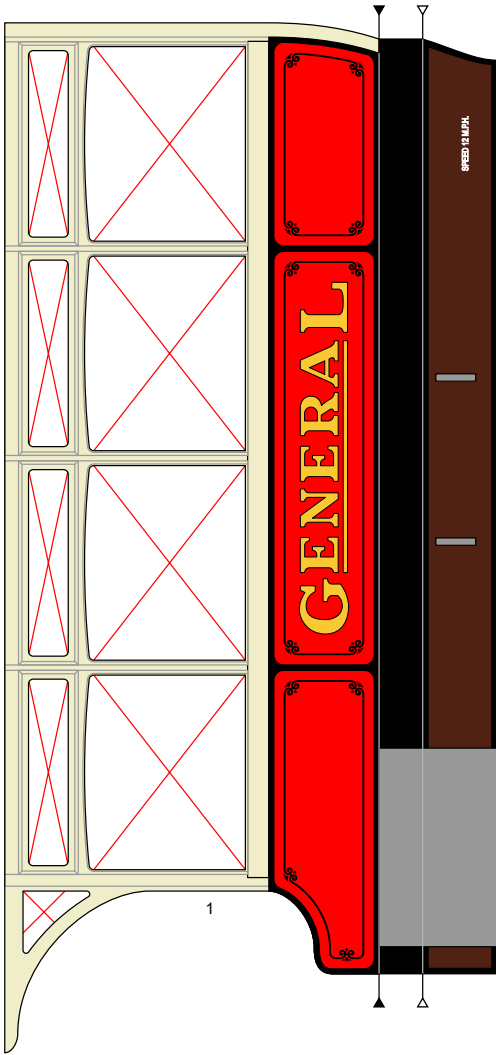

B-TYPE LONDON BUS 1:32
C: LOWER DECK FULL

- C1 -

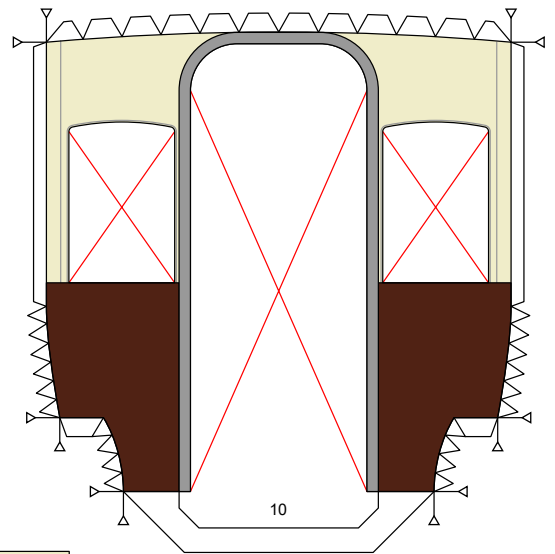
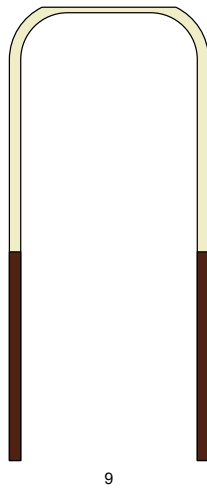
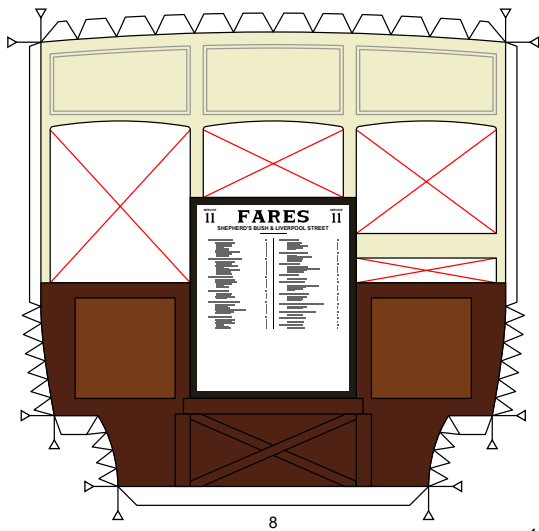
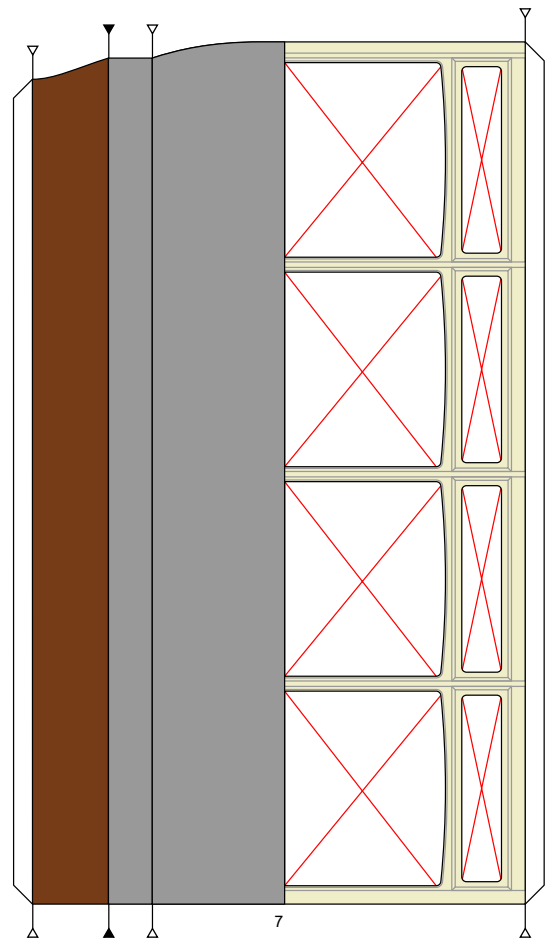
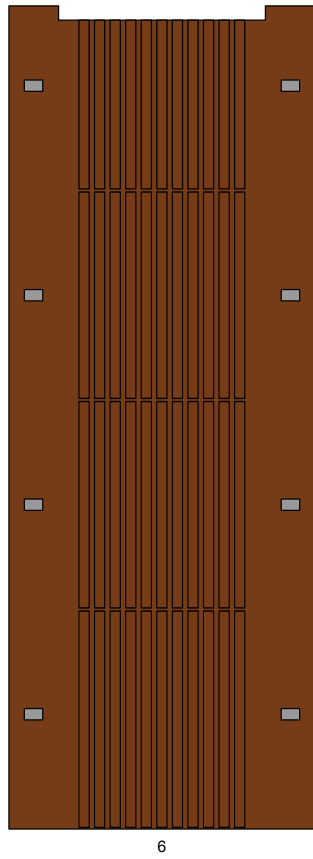
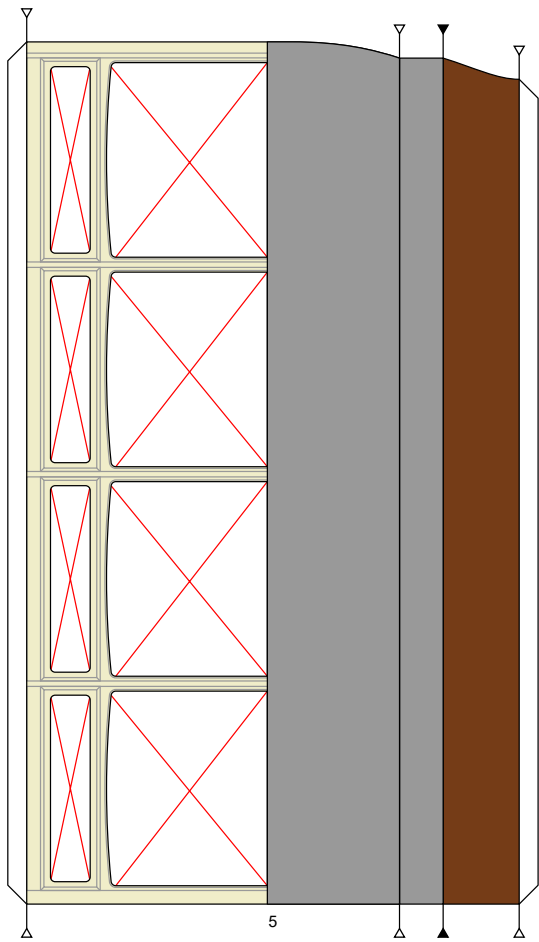

11

FRONT

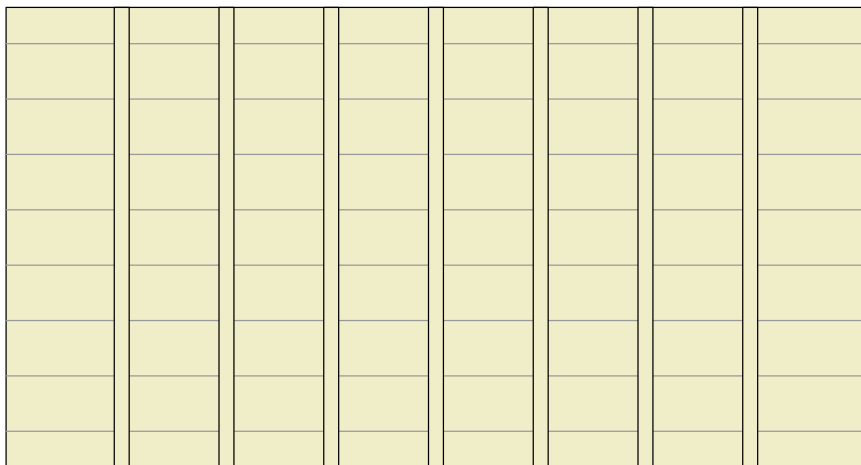

BACK

B-TYPE LONDON BUS 1:32
C: LOWER DECK FULL

- C2 -

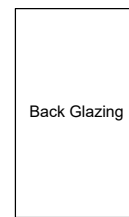
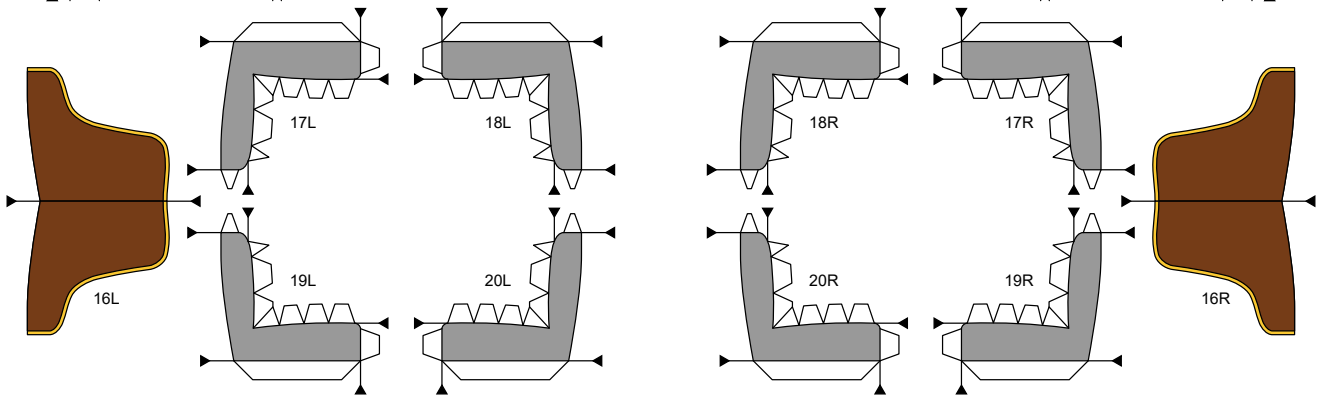
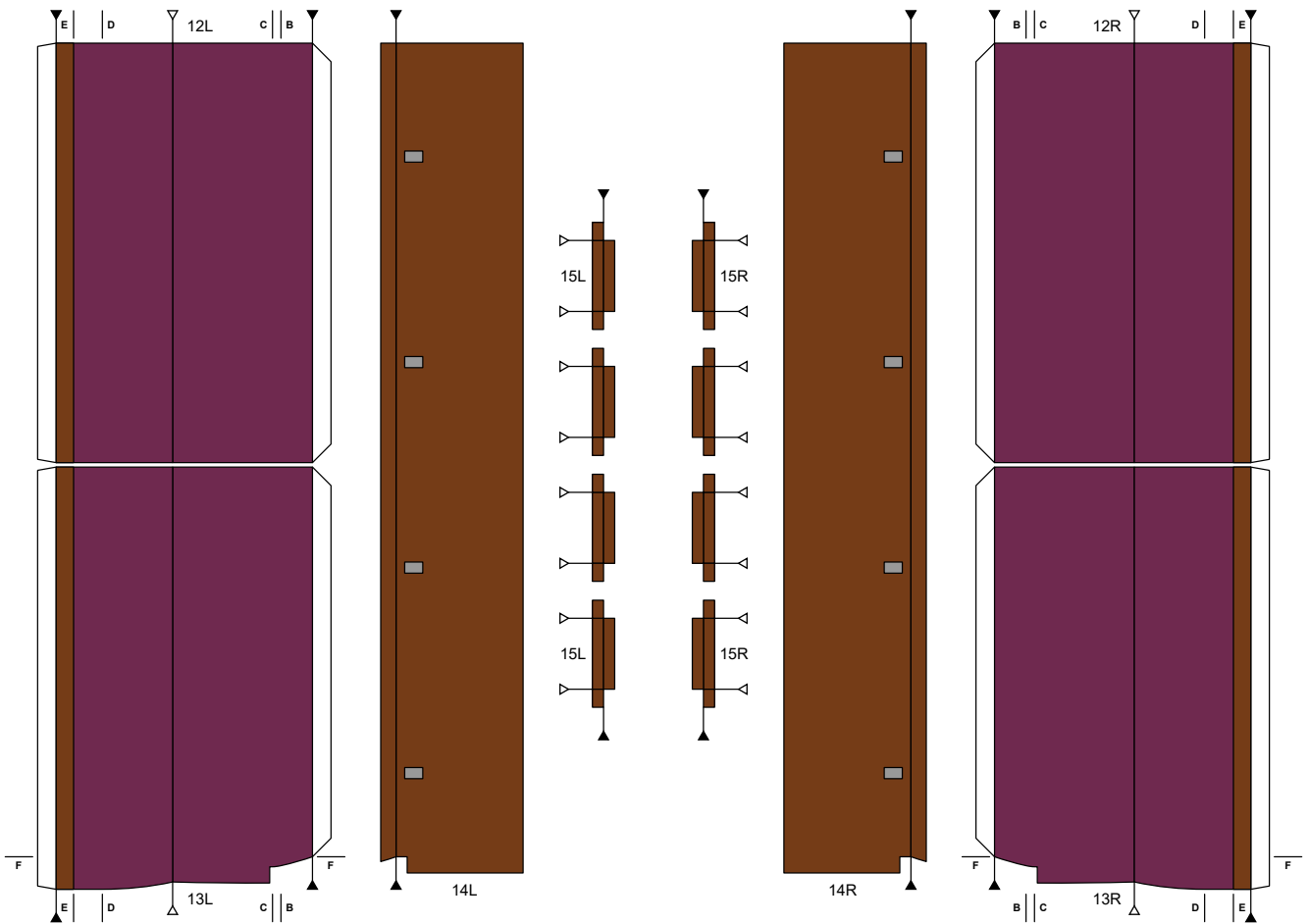

B-TYPE LONDON BUS 1:32
C: LOWER DECK FULL

- C3 -

Alan Grayer 2020
 btype@grayer.me.uk

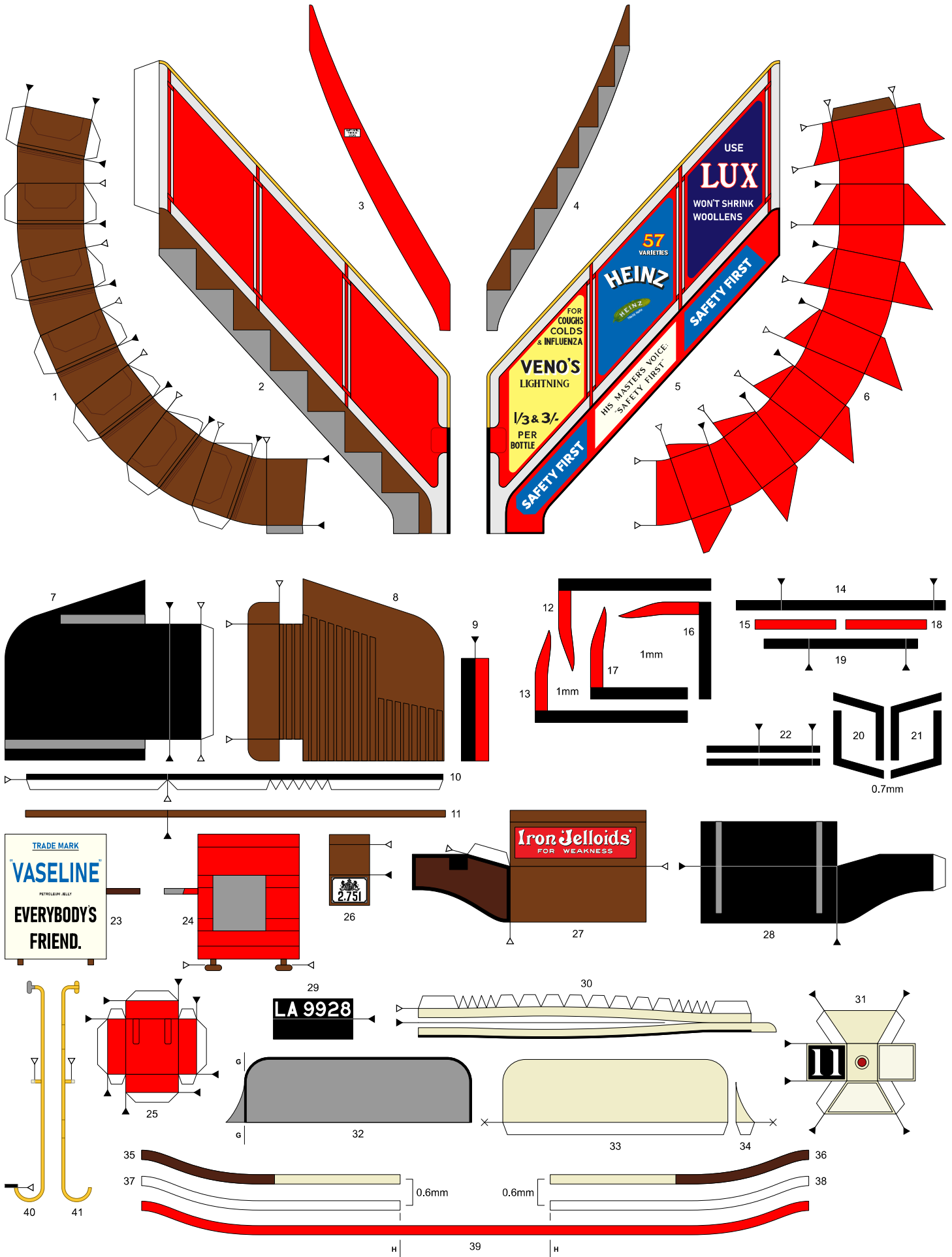

B-TYPE LONDON BUS 1:32
D: PLATFORM AND STAIRS - D1 -

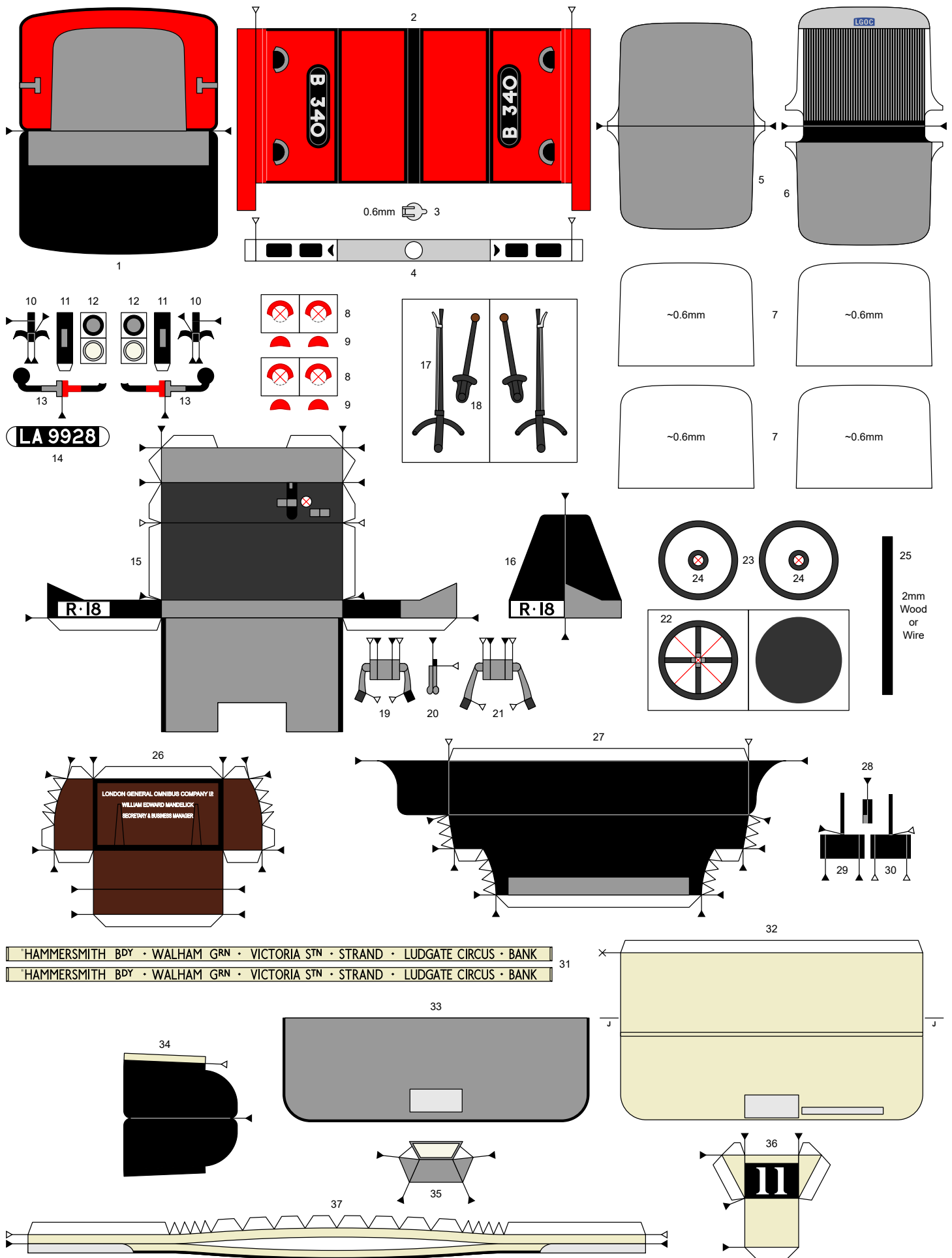

B-TYPE LONDON BUS 1:32
E: FRONT END

- E1 -

Alan Grayer 2020
 btype@grayer.me.uk

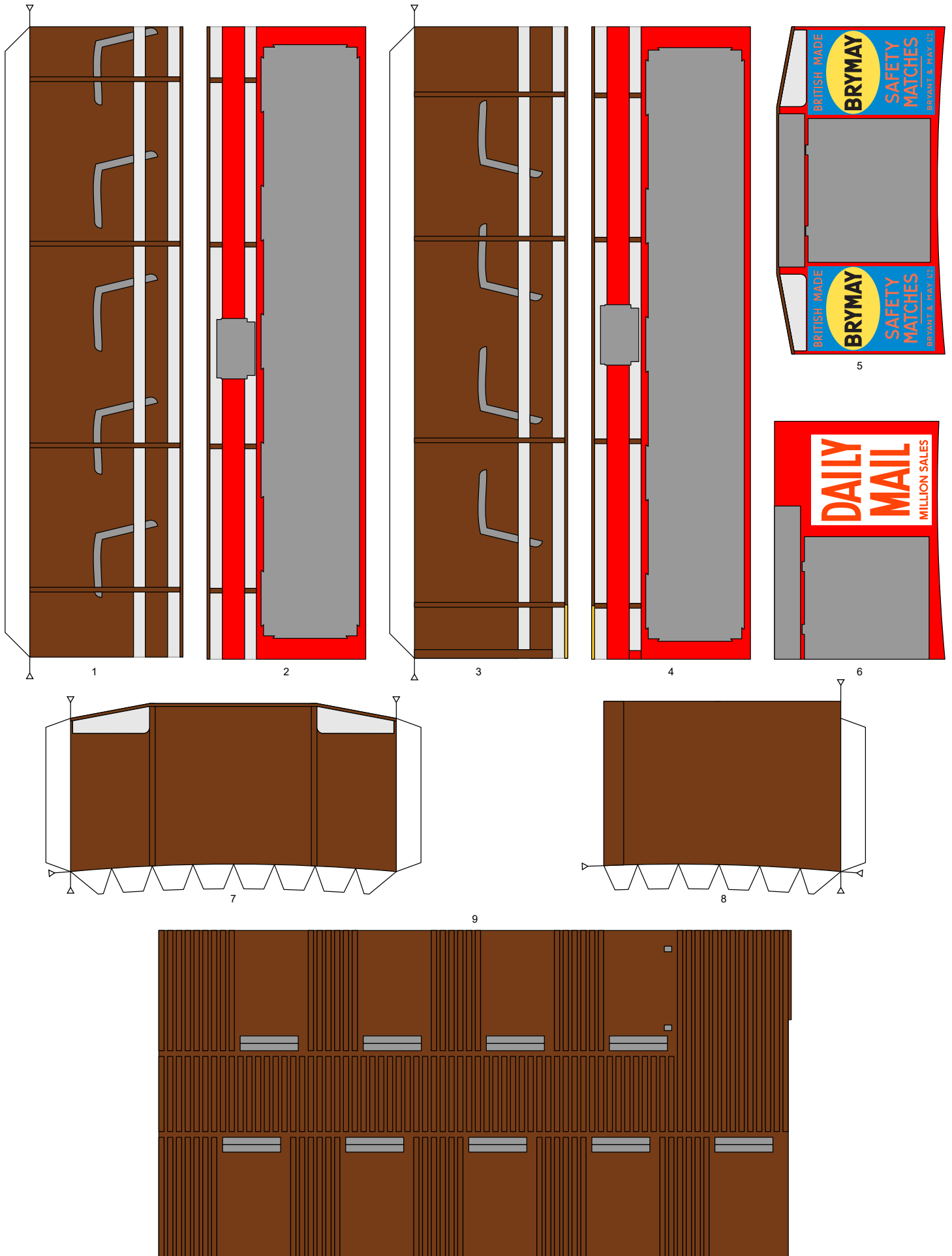

B-TYPE LONDON BUS 1:32
F: UPPER DECK

- F1 -

Alan Grayer 2020
 btype@grayer.me.uk

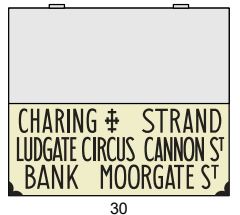
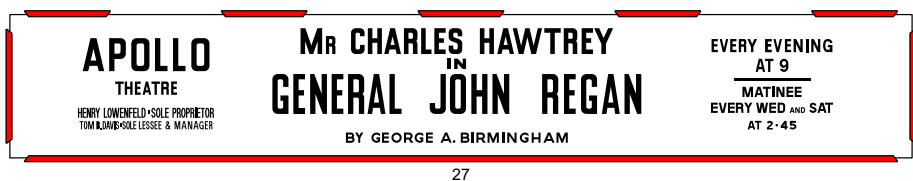
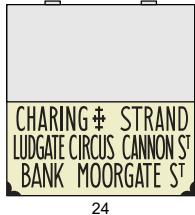
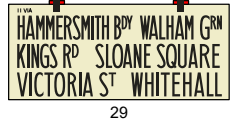
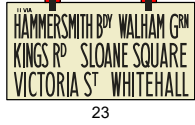
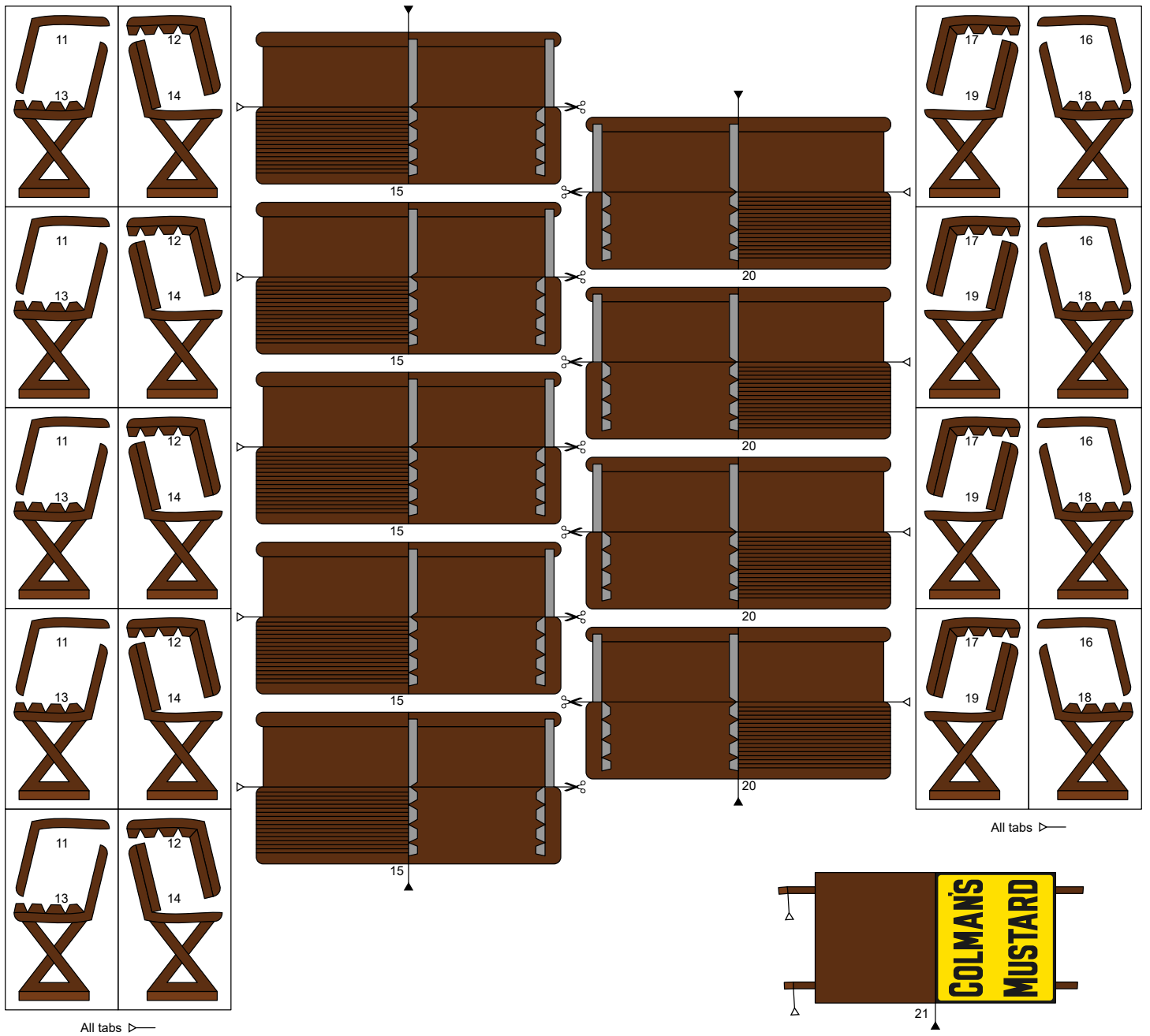

B-TYPE LONDON BUS 1:32
F: UPPER DECK

- F2 -

Alan Grayer 2020
 btype@grayer.me.uk

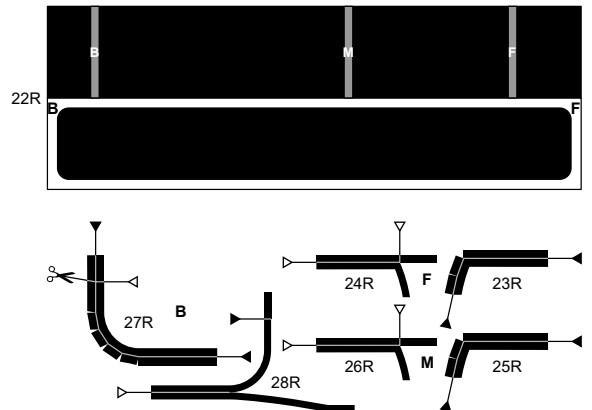
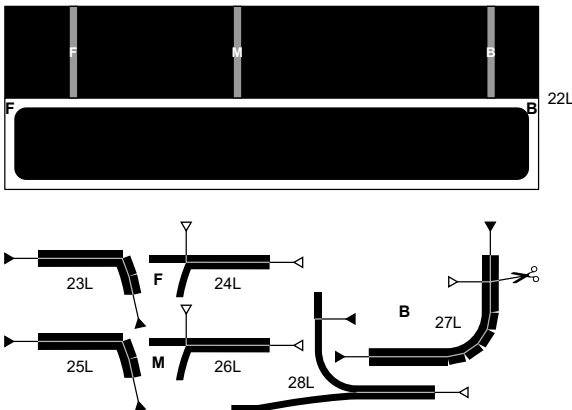
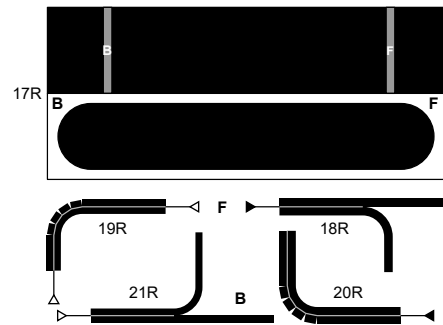
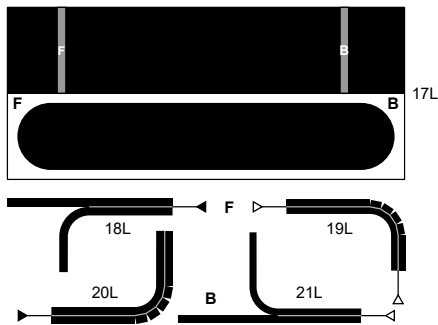
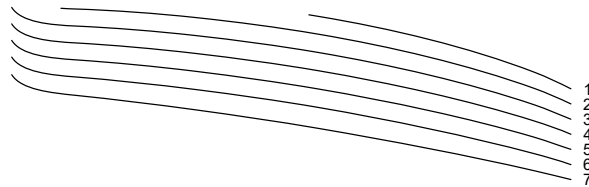
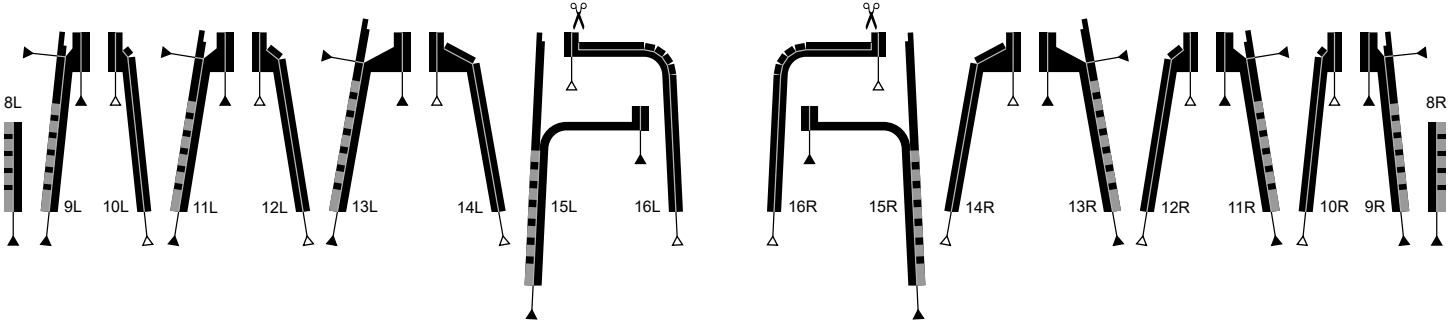
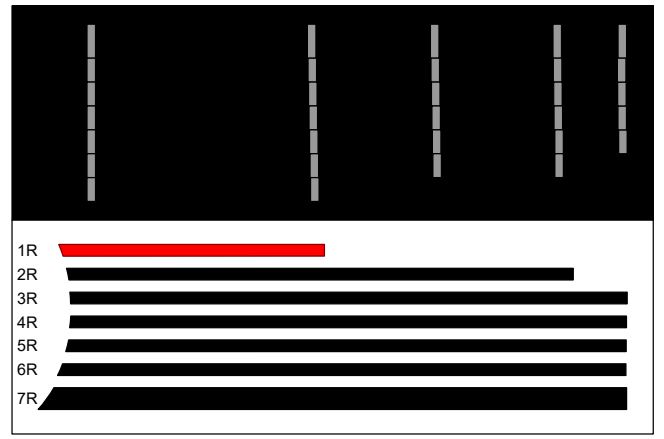
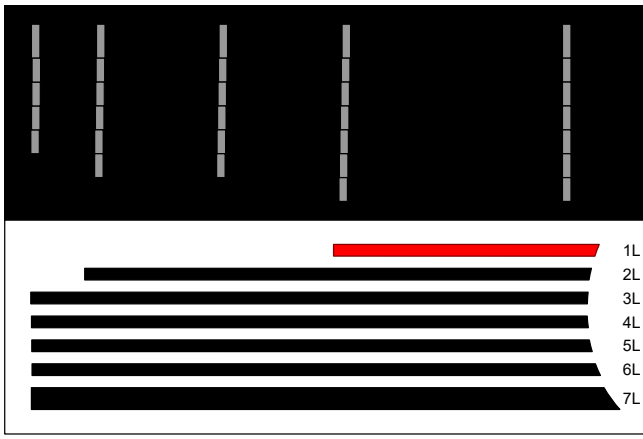

B-TYPE LONDON BUS 1:32
G: GUARDS

- G1 -

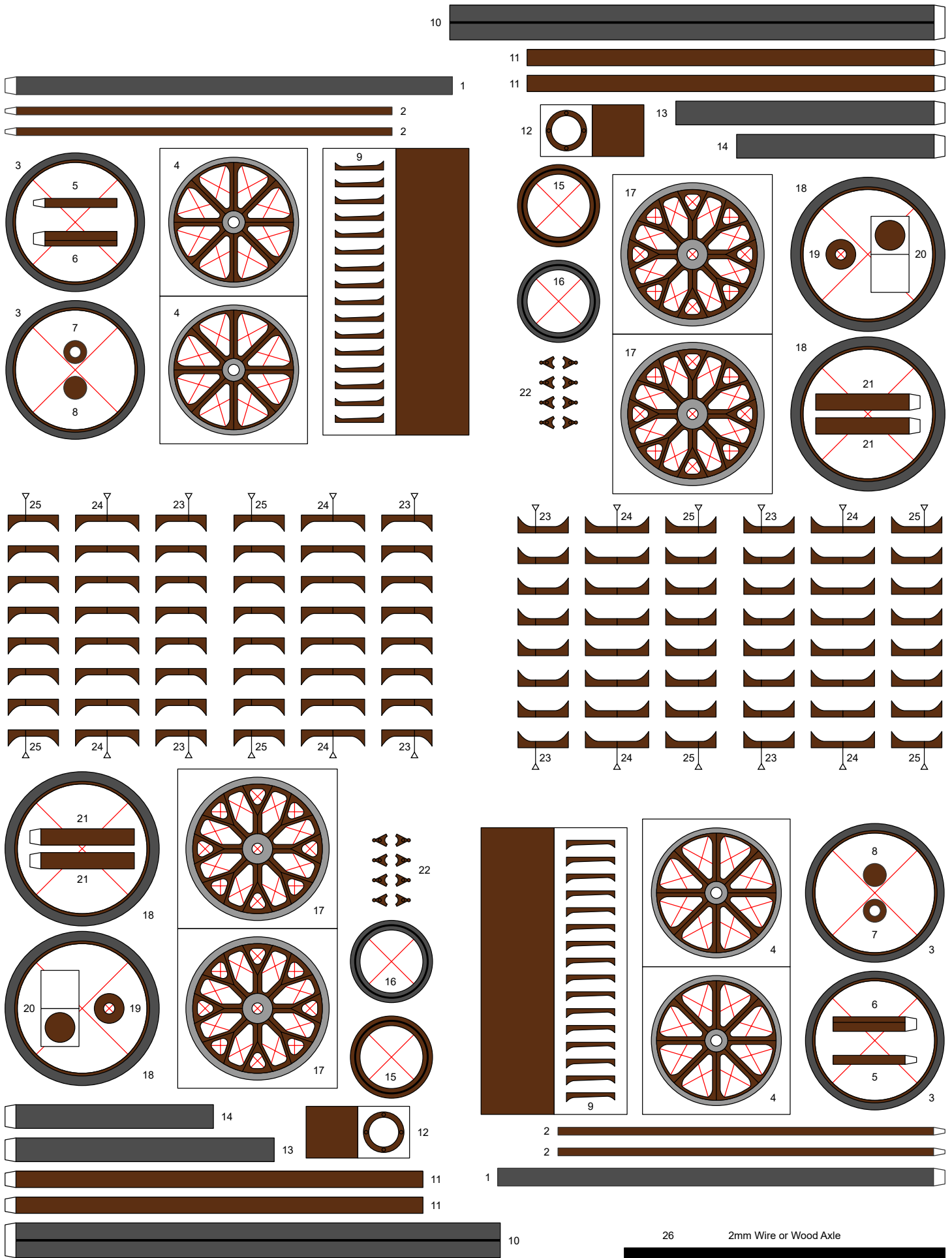

B-TYPE LONDON BUS 1:32
H: WHEELS

- H1 -

Alan Grayer 2020
 btype@grayer.me.uk