

K-TYPE LONDON BUS



PAPER MODEL V1.0

Scale 1:32

Alan Grayer 2020
ktype@grayer.me.uk

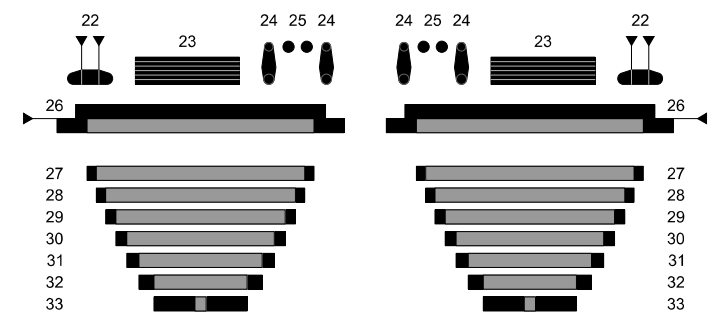
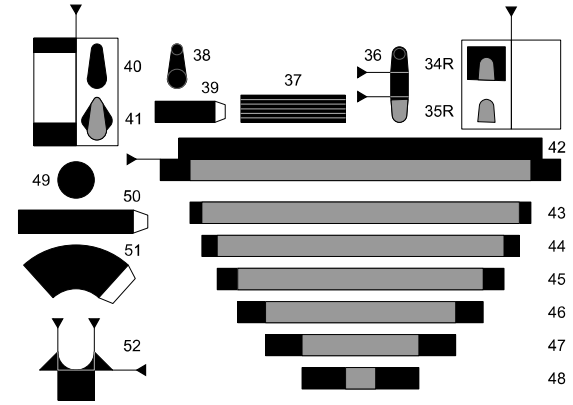
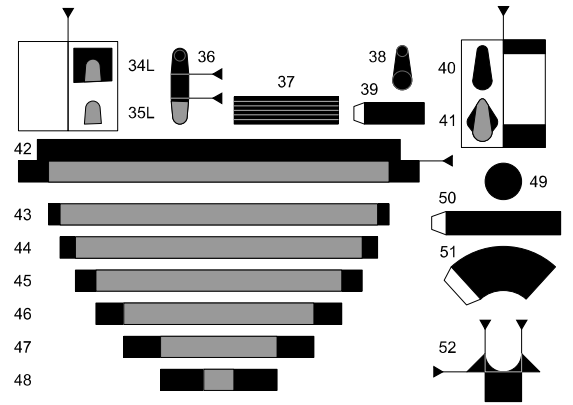
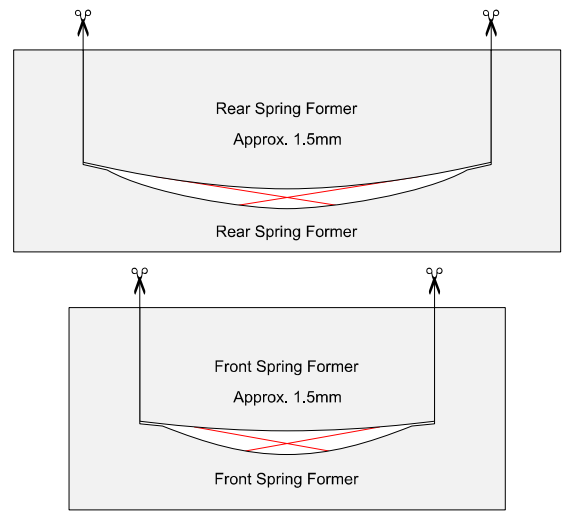
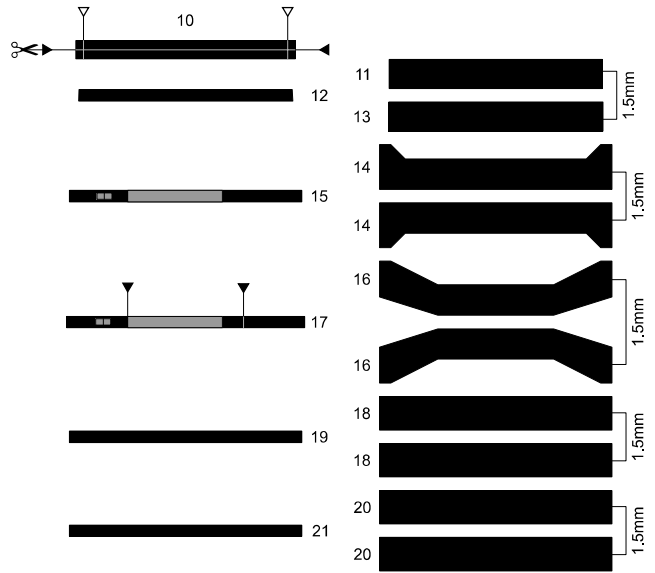
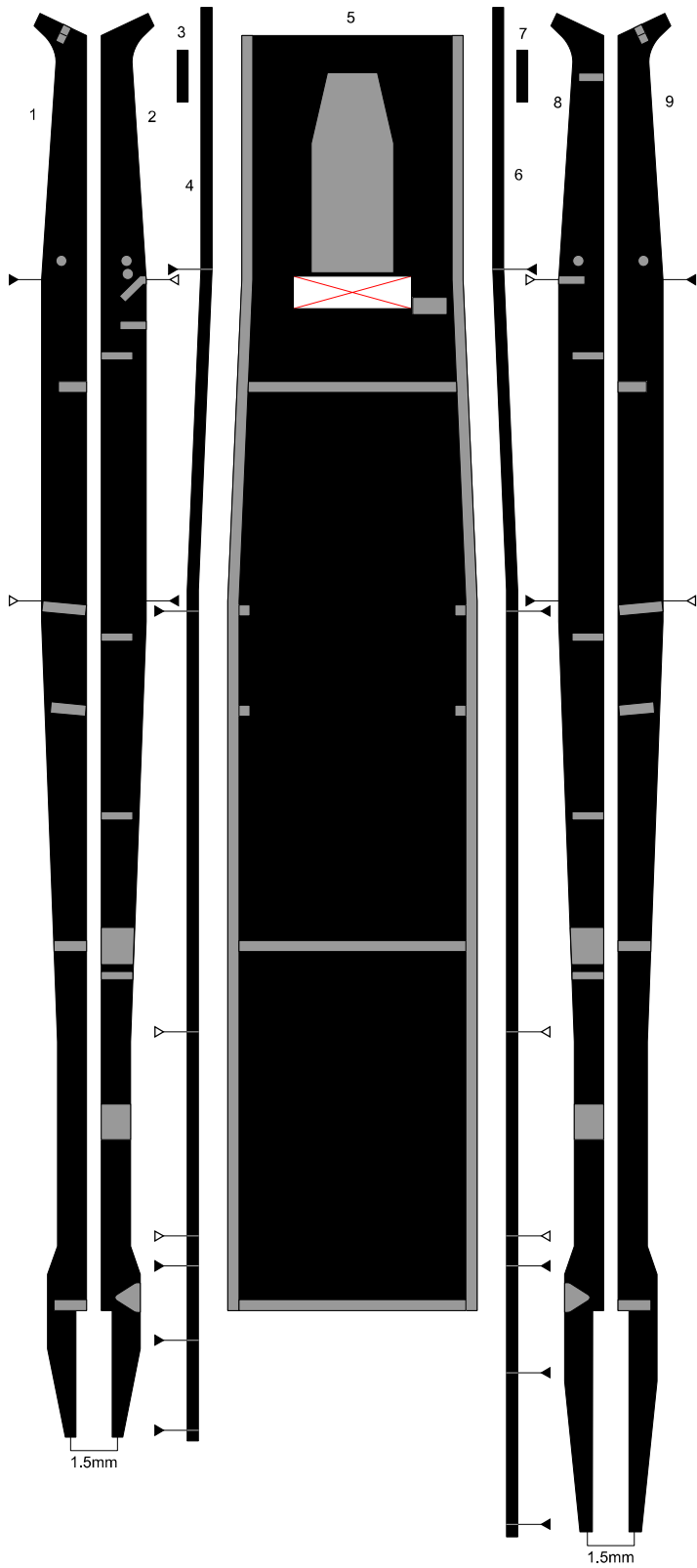

K-TYPE LONDON BUS 1:32
A: CHASSIS

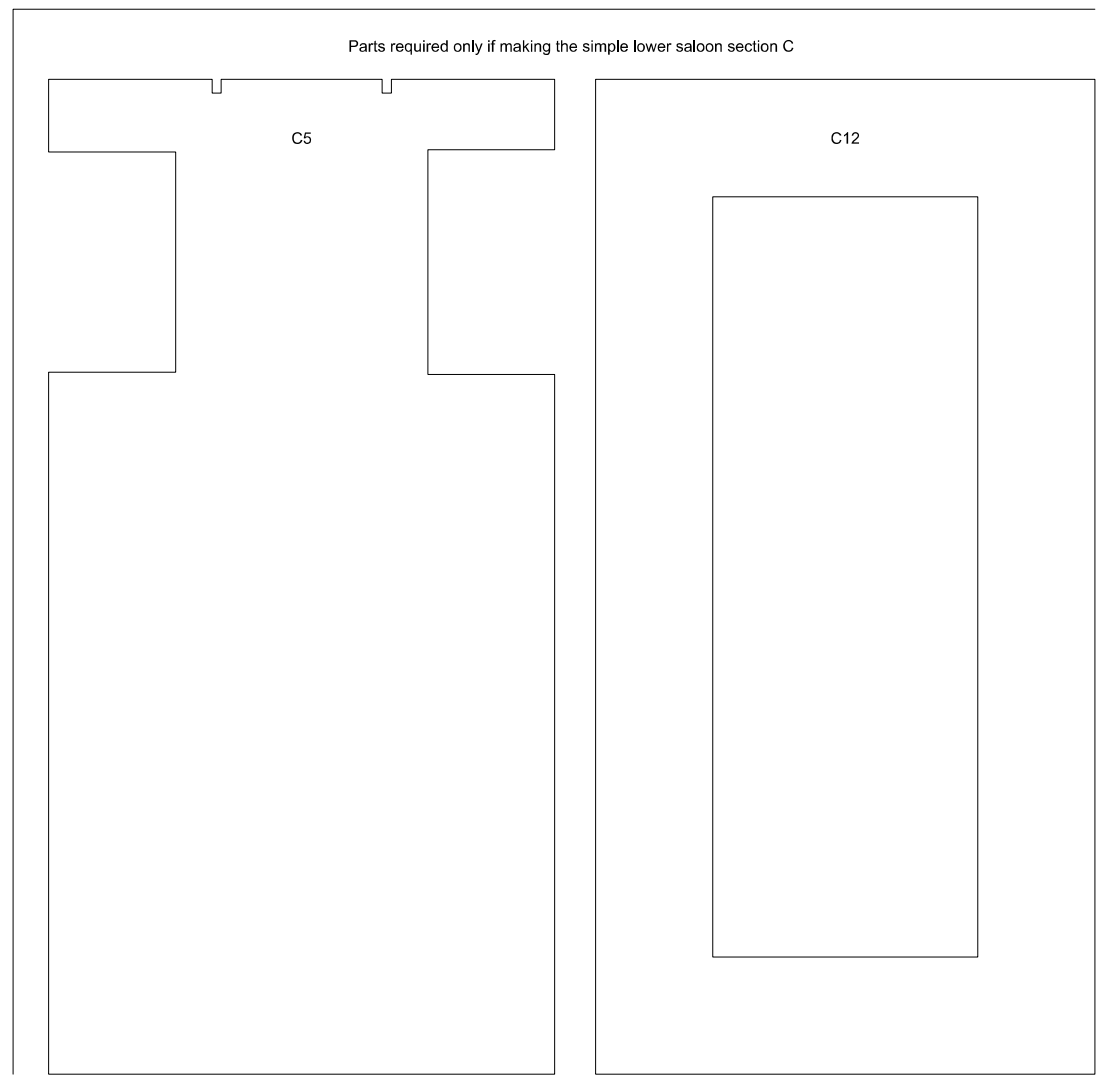
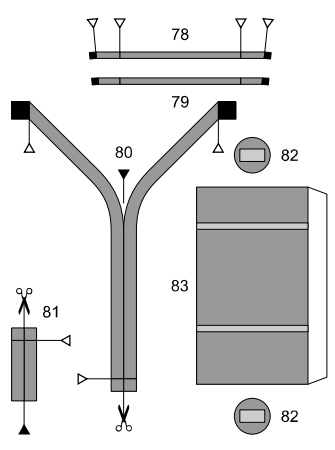
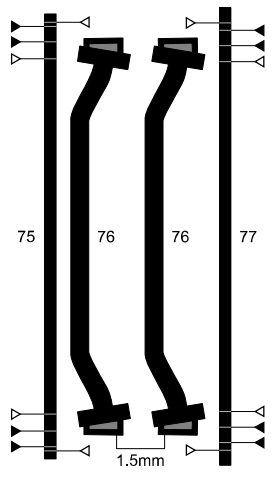
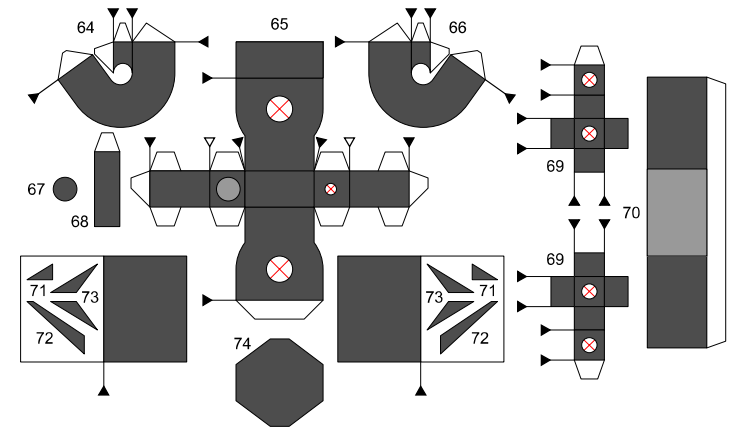
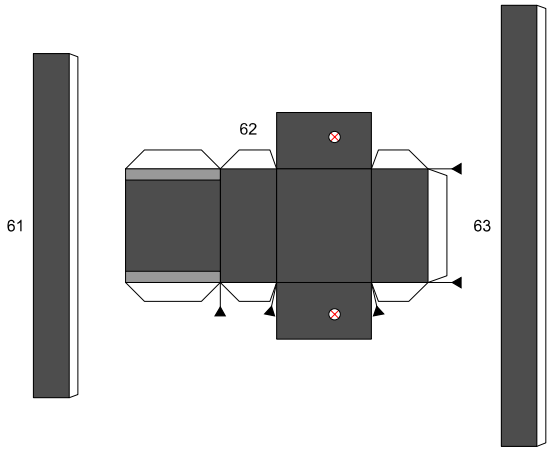
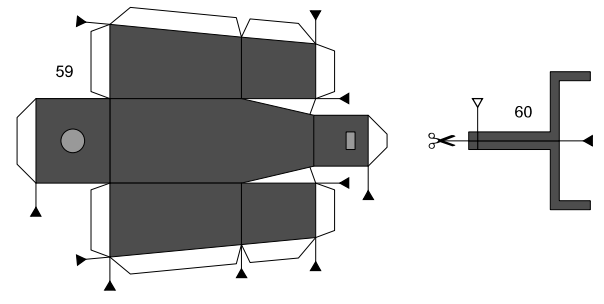
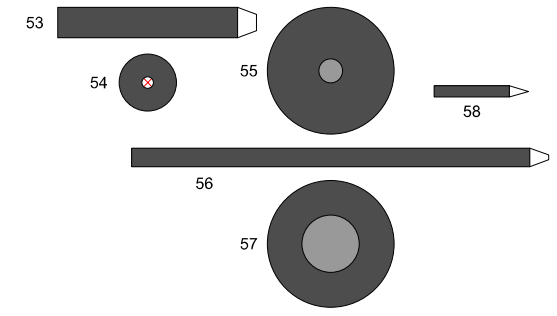

K-TYPE LONDON BUS 1:32
A: CHASSIS

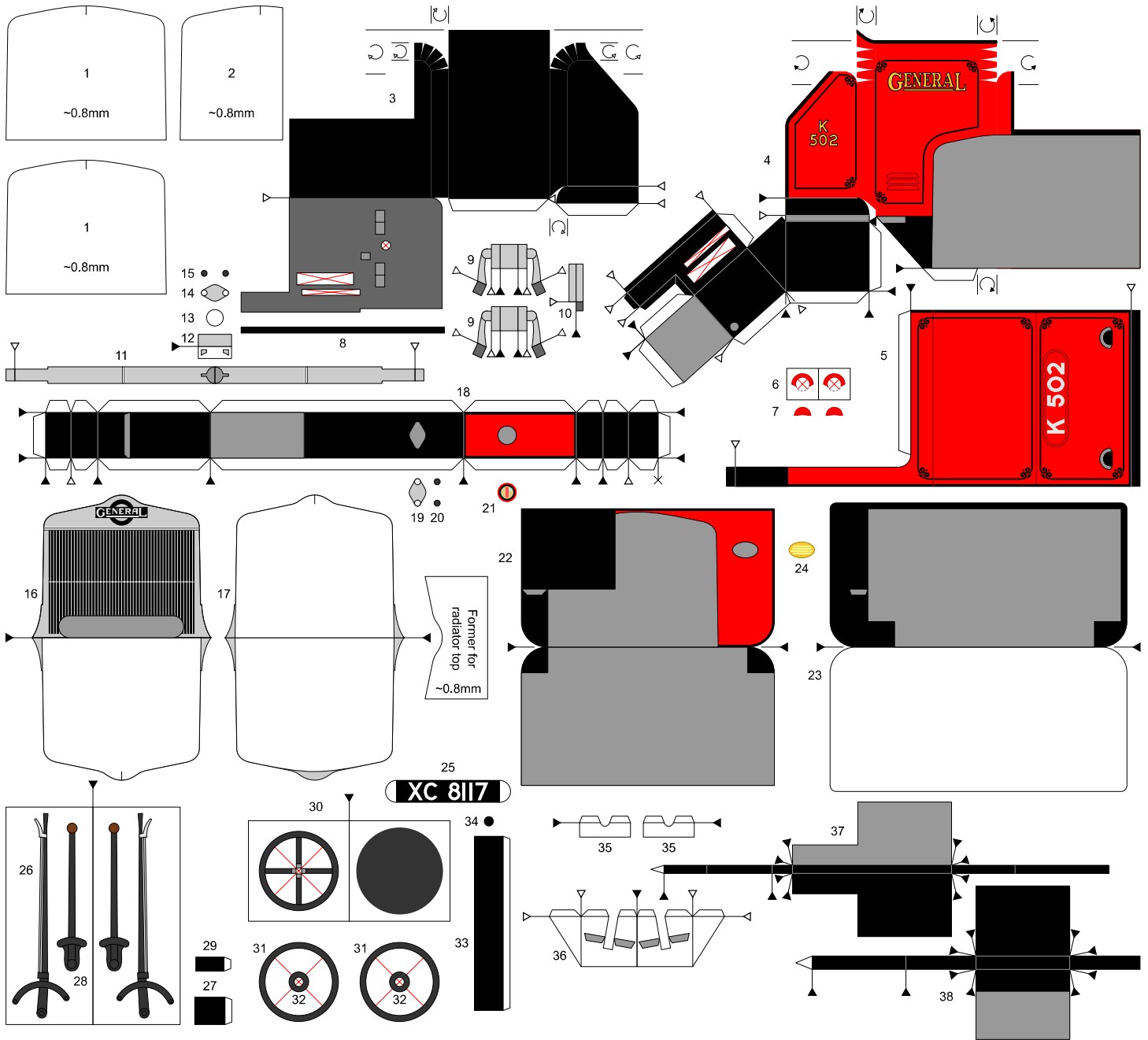

Simplified driver's enclosure

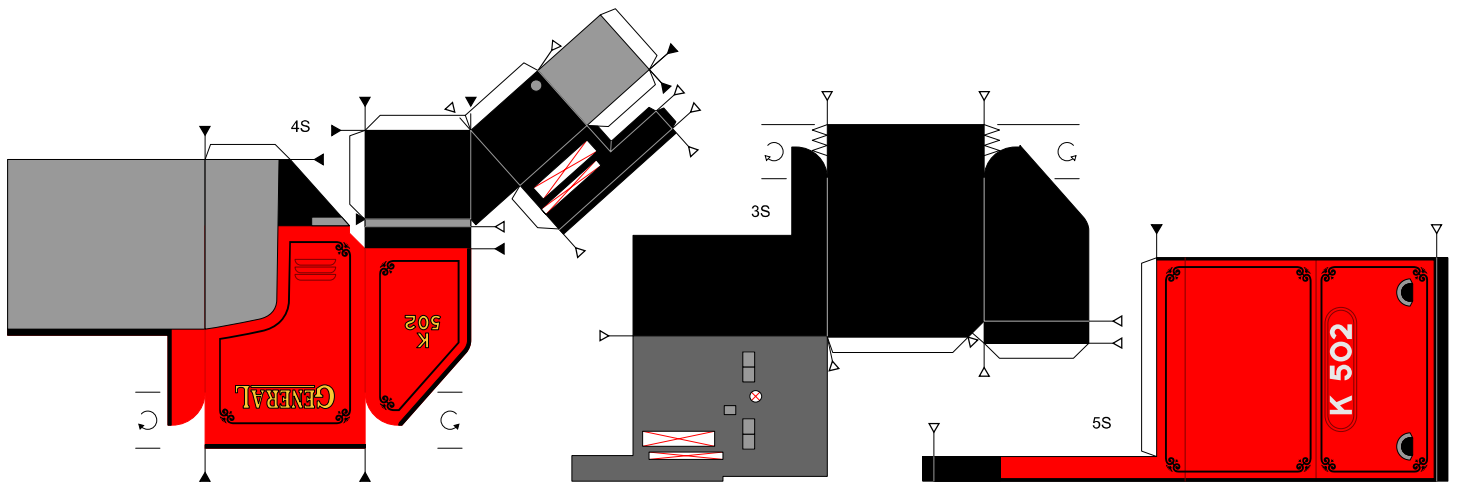

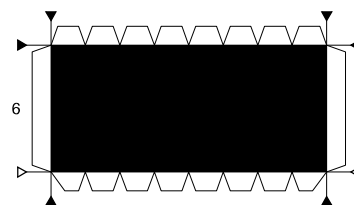
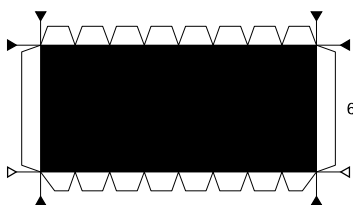
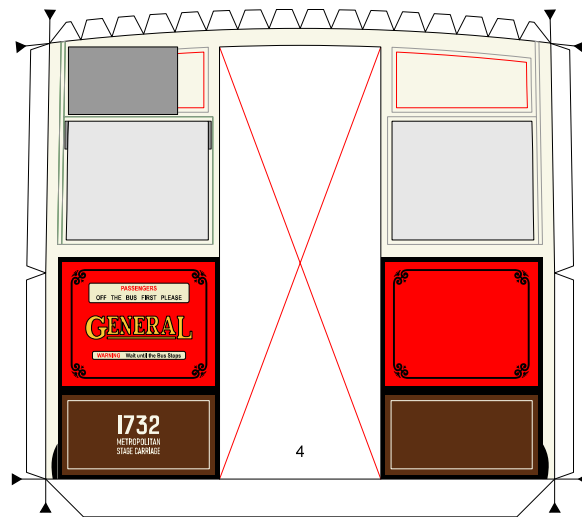
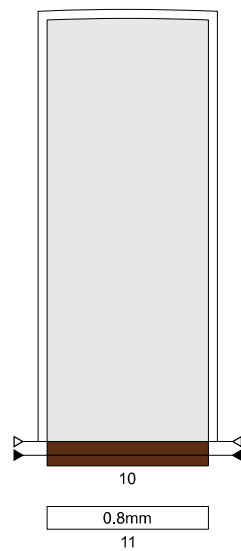
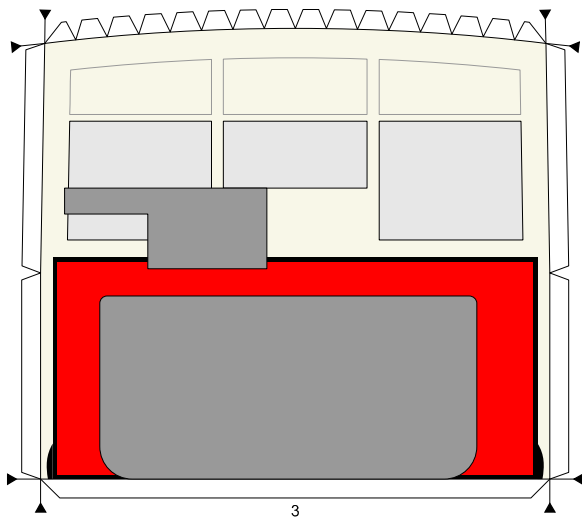
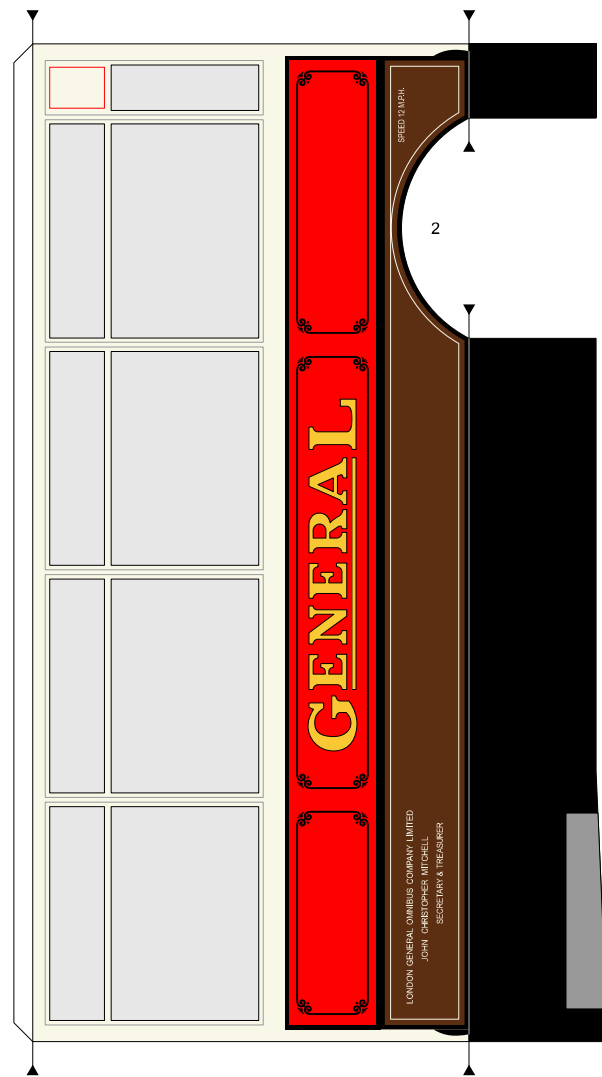
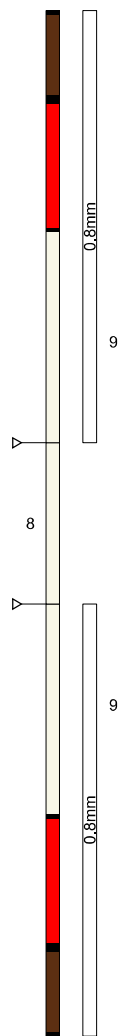
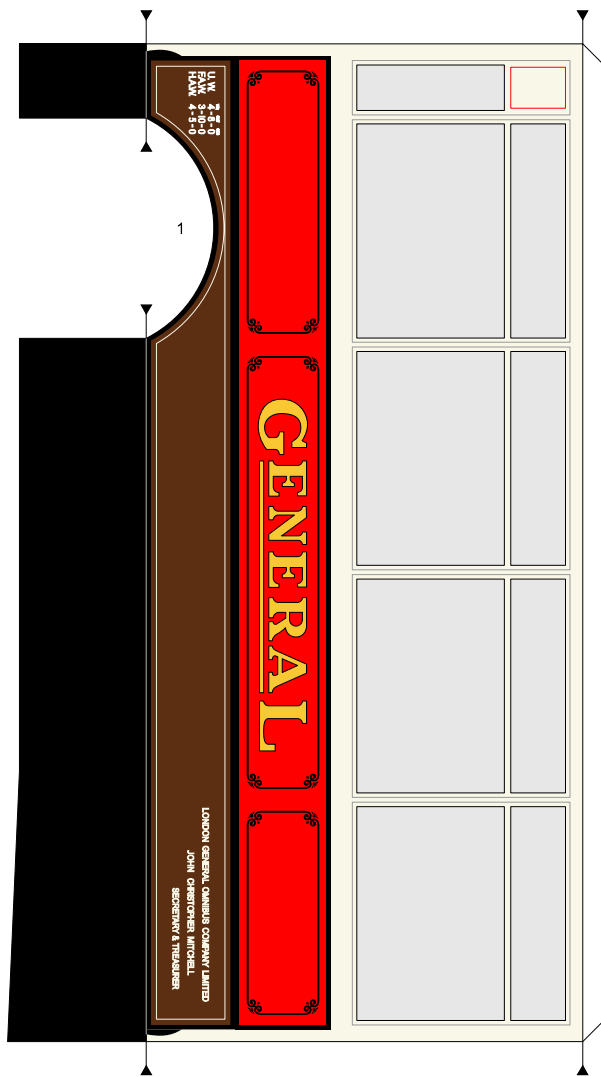

For parts 5 and 12 see page A2



K-TYPE LONDON BUS 1:32

C: SIMPLE LOWER DECK - C1 -

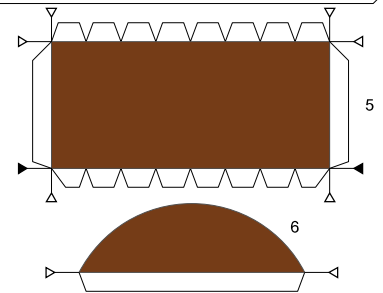
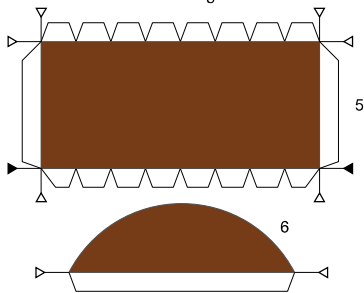
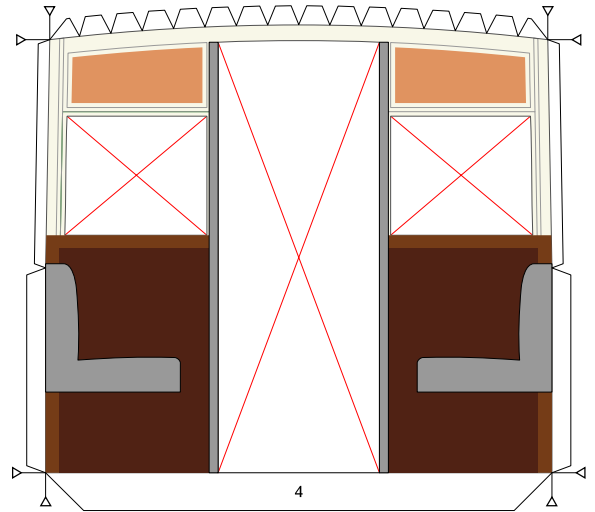
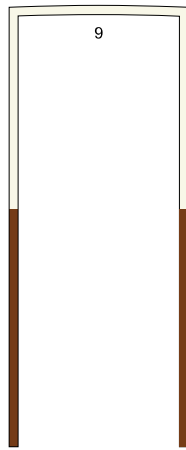
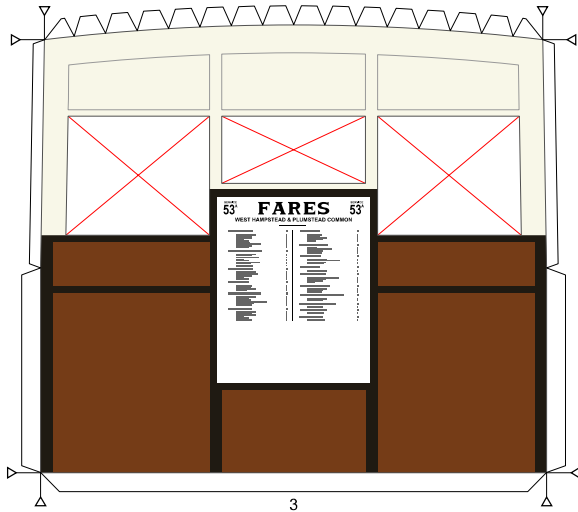
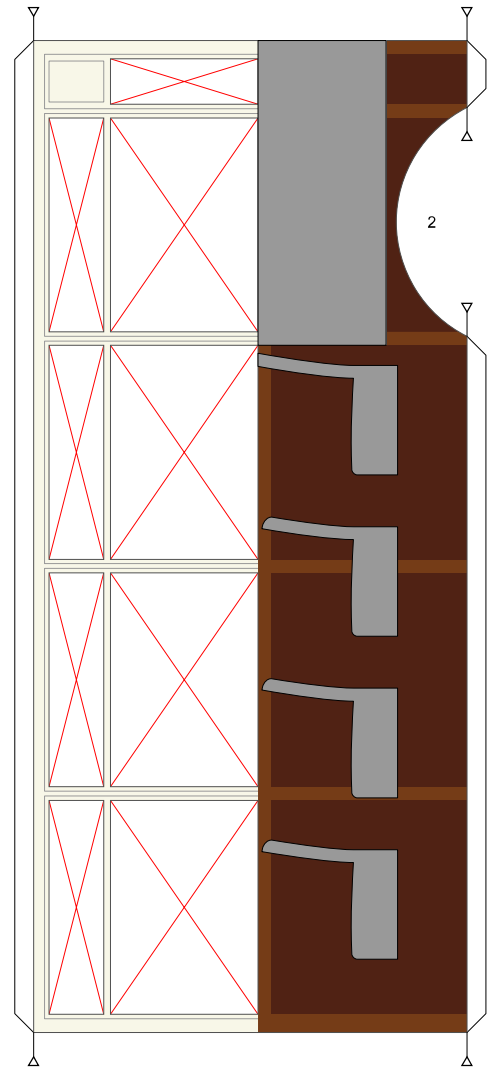
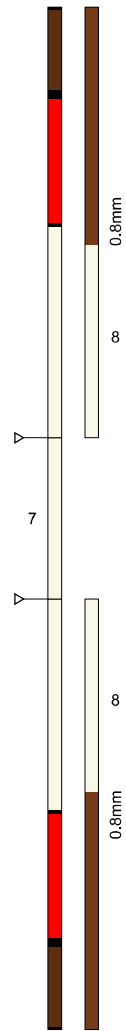
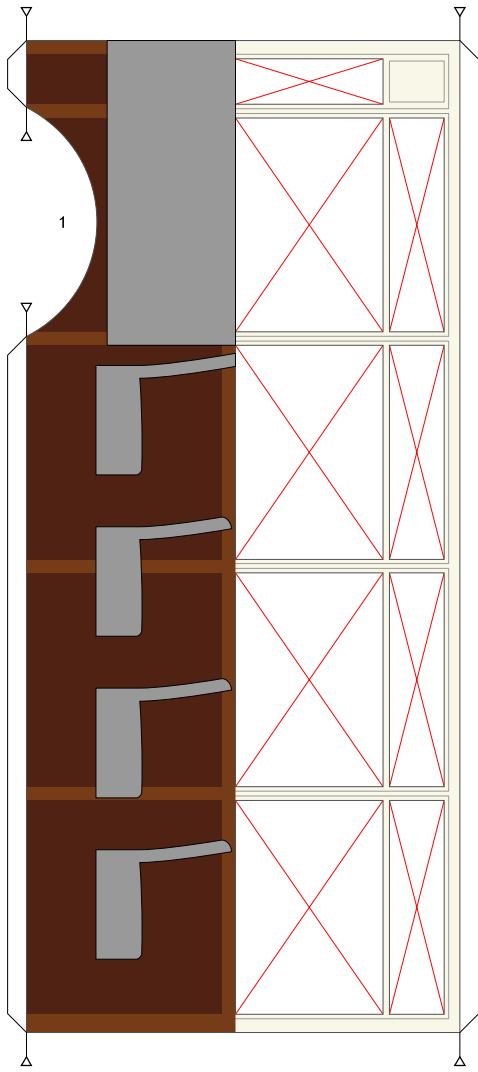

K-TYPE LONDON BUS 1:32
D: FULL LOWER SALOON - D1 -

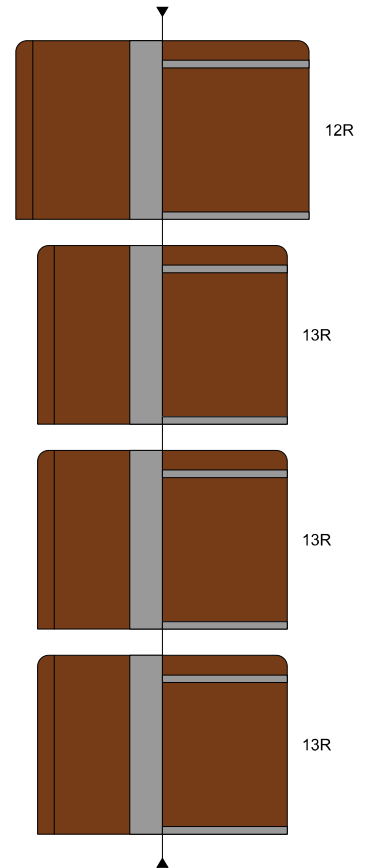
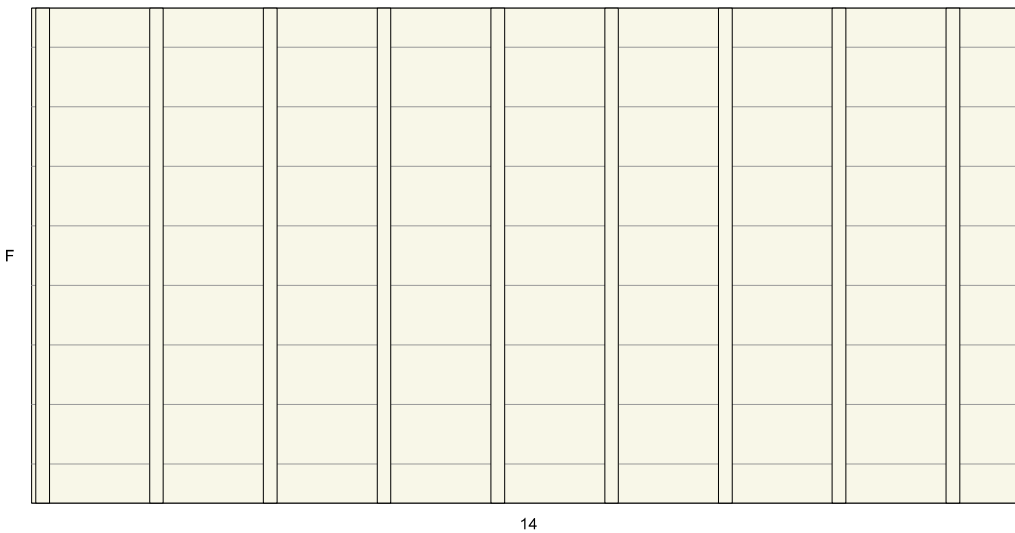
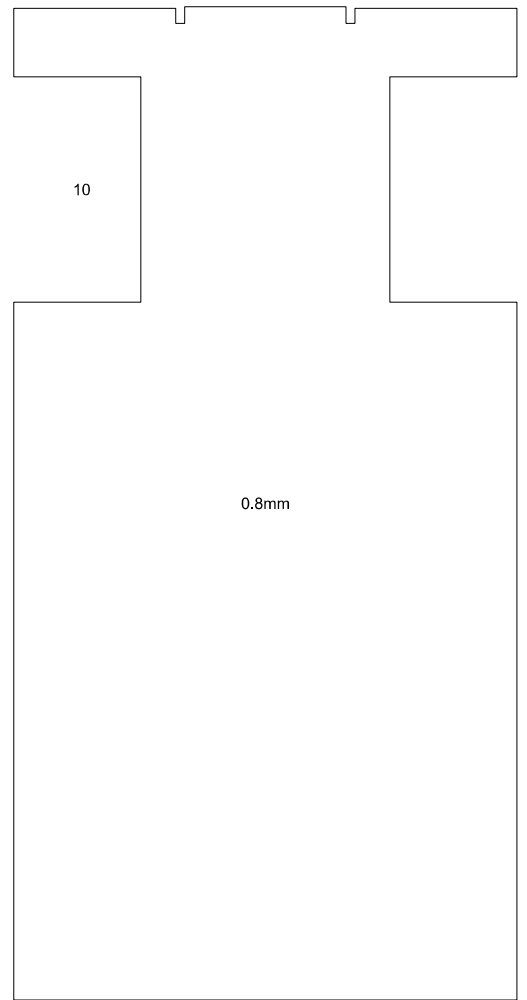
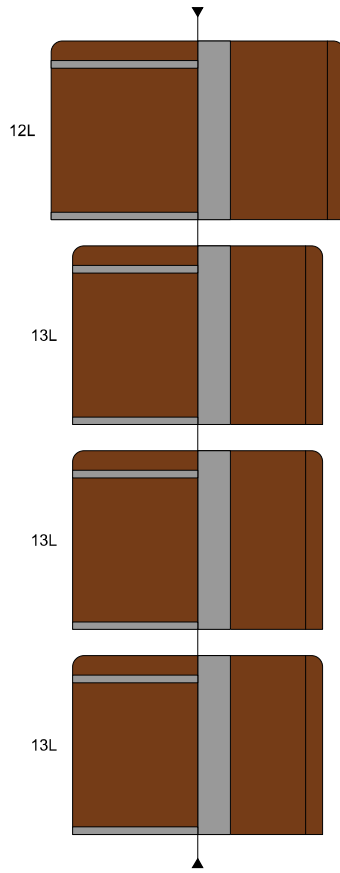
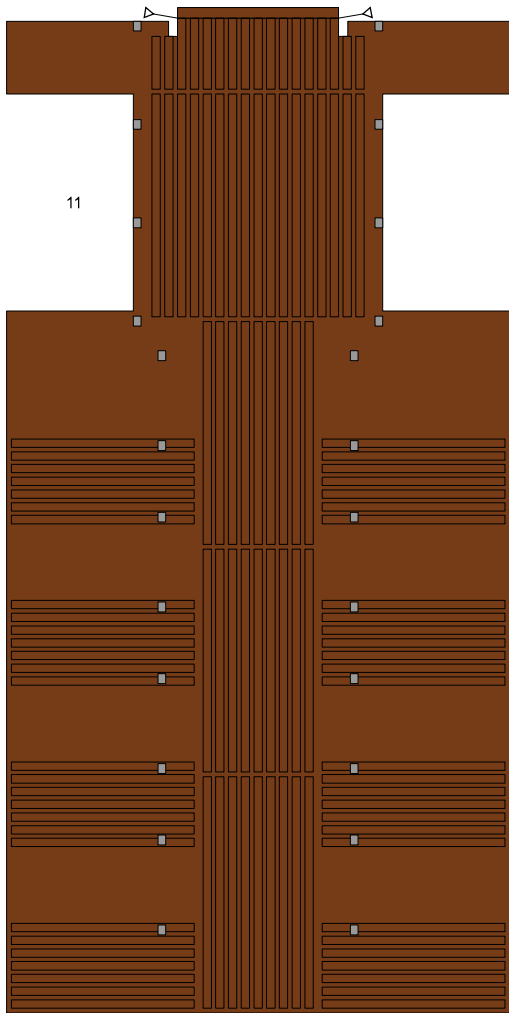

K-TYPE LONDON BUS 1:32
D: FULL LOWER SALOON - D2 -

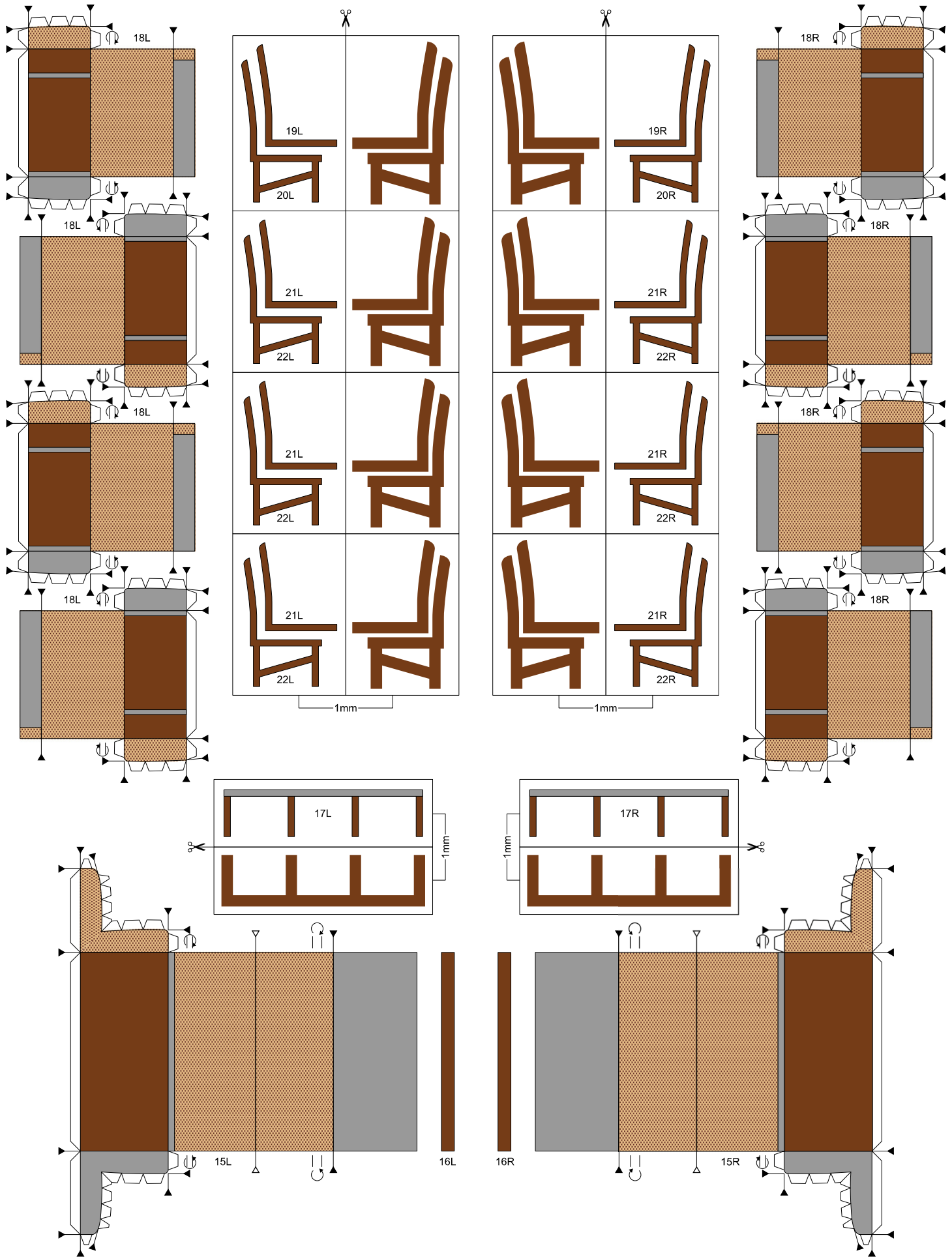

K-TYPE LONDON BUS 1:32
D: FULL LOWER SALOON - D3 -

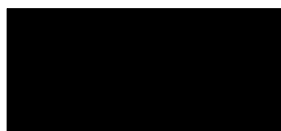
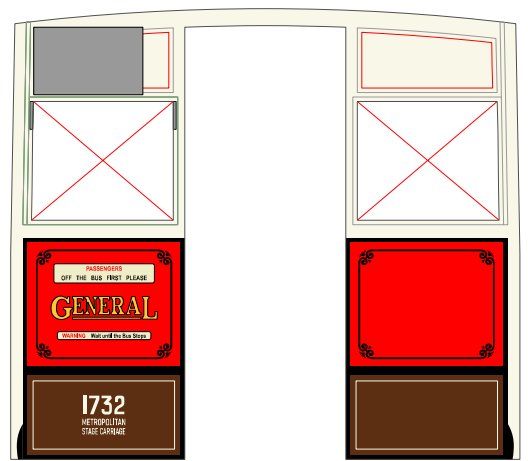
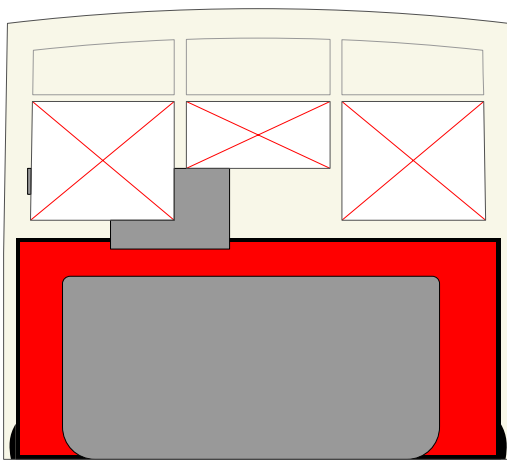
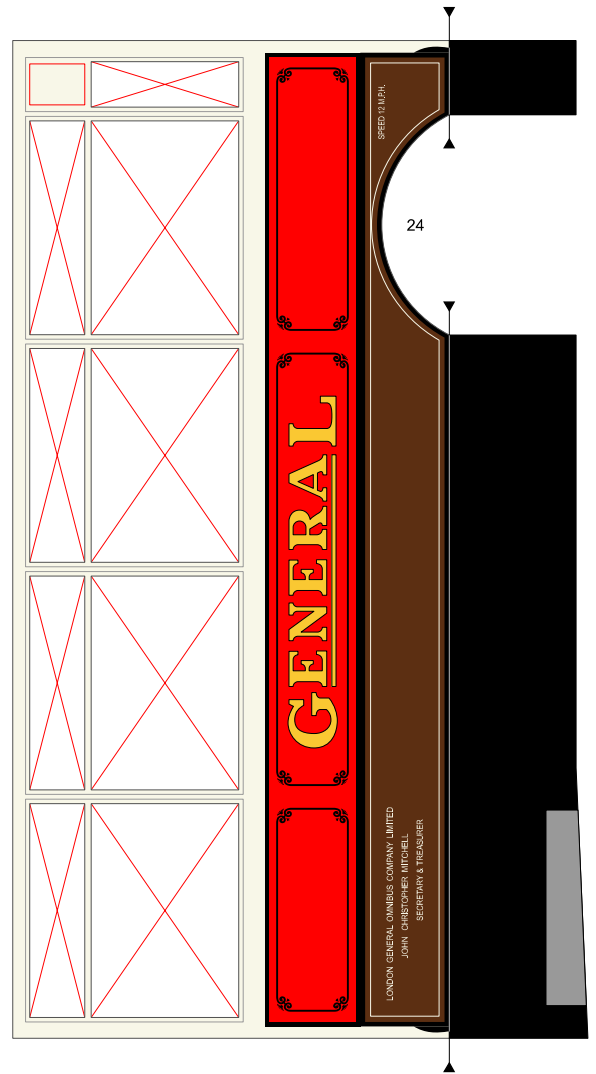
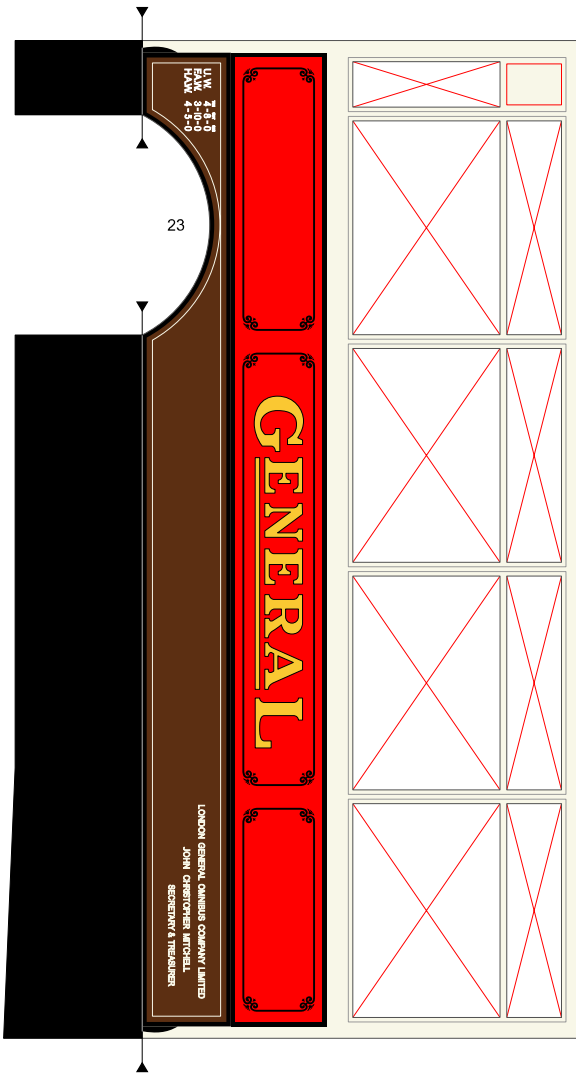

27



28

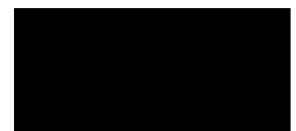

27



28

K-TYPE LONDON BUS 1:32

D: FULL LOWER SALOON - D4 -

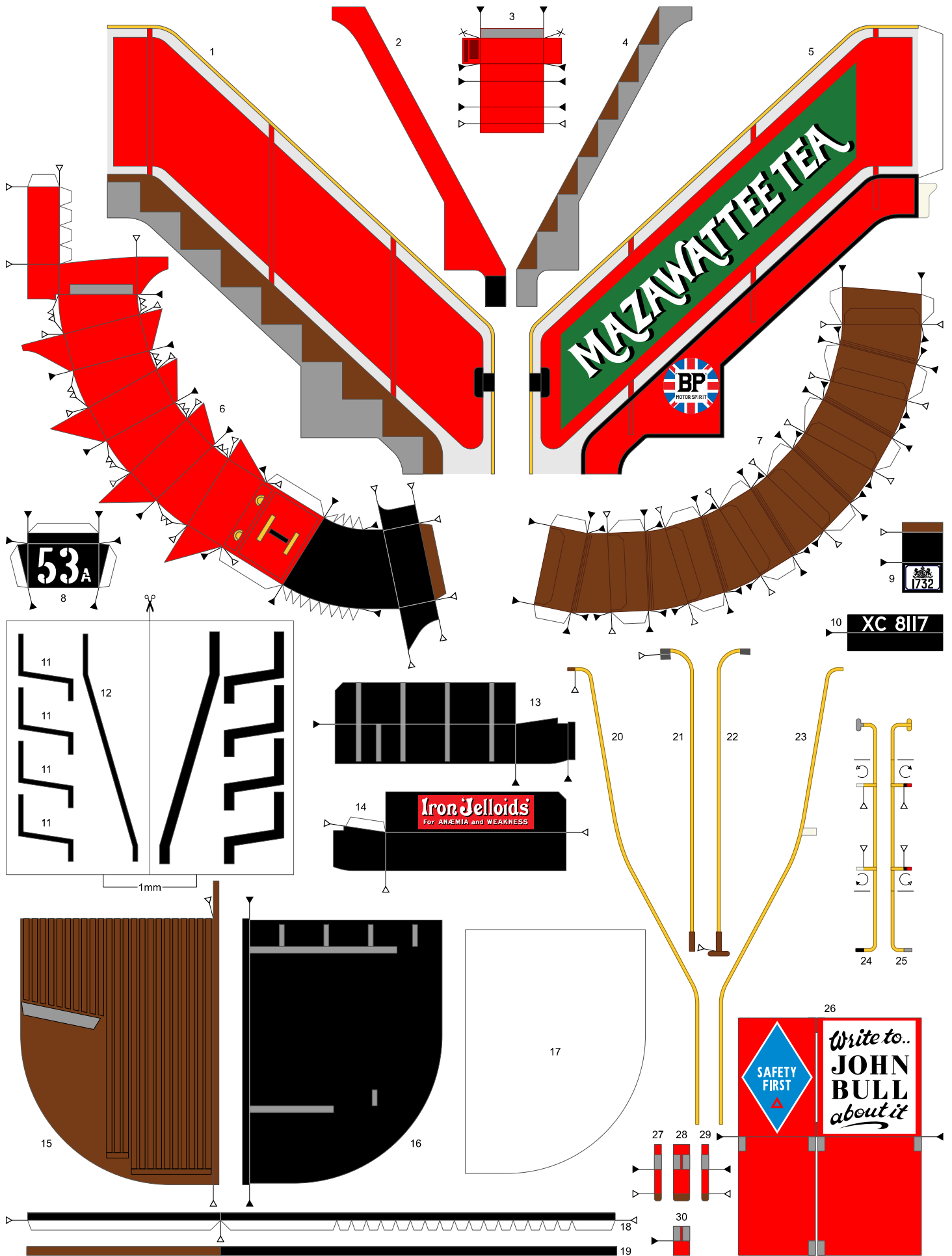

K-TYPE LONDON BUS 1:32
E: PLATFORM & STAIRS - E1 -

Alan Grayer 2020
 ktype@grayer.me.uk

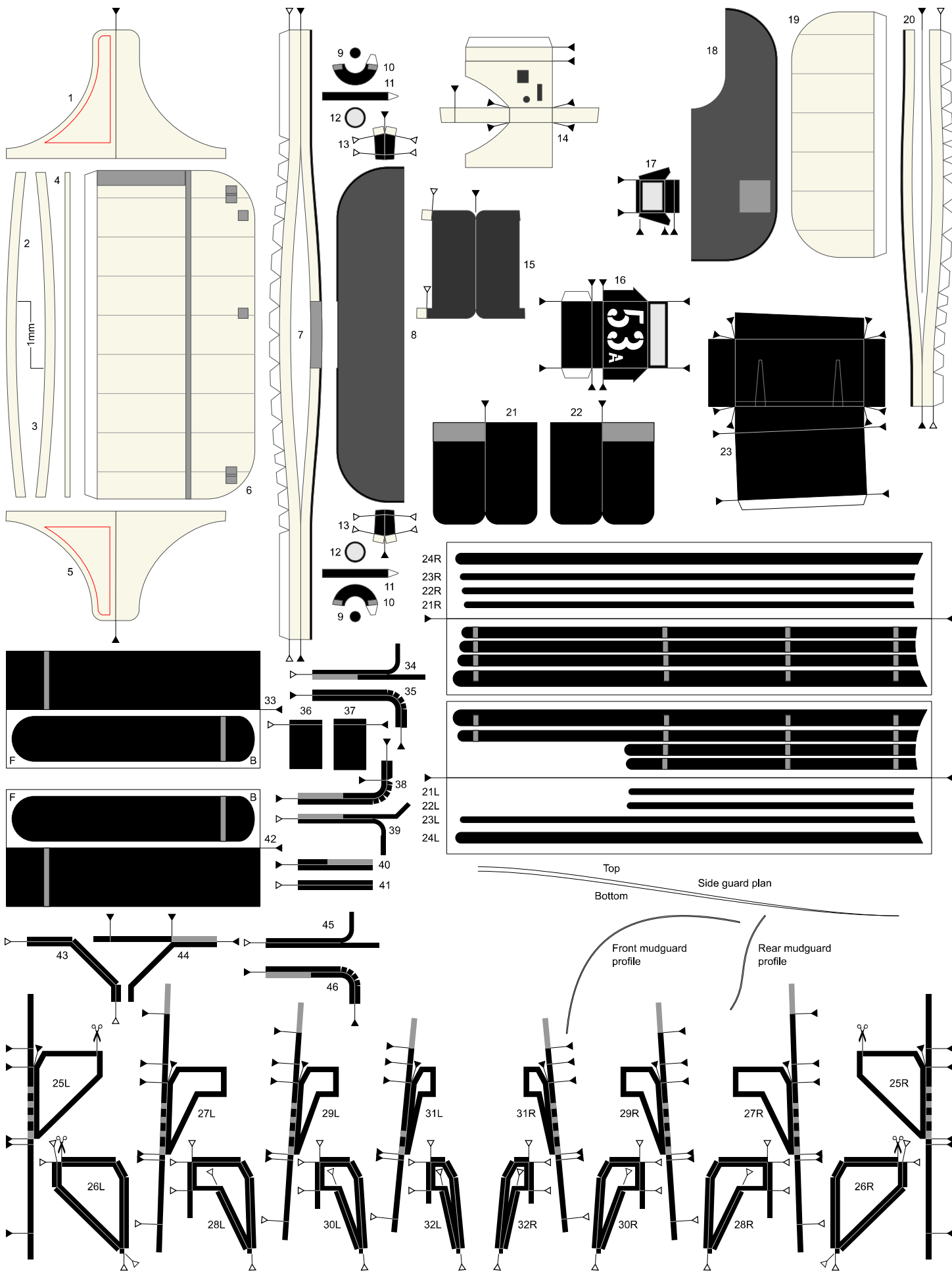

K-TYPE LONDON BUS 1:32
F: CANOPIES & GUARDS - F1 -

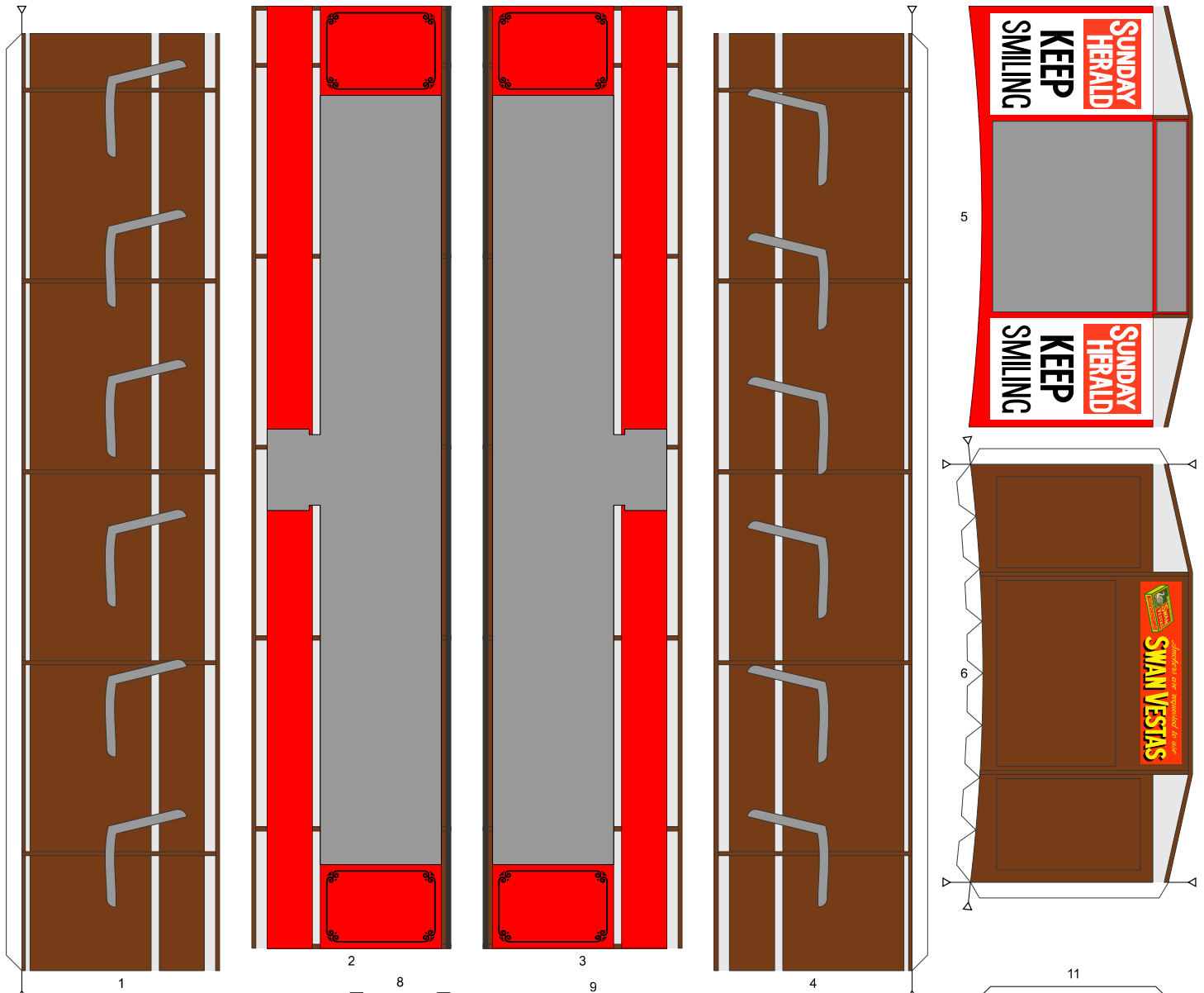

7
 ABBEY RD ST JOHNSWOOD RD
 BAKER ST WIGMORE ST
 REGENT ST WHITEHALL

8
 ST GEORGES RD OLD KENT RD
 NEW F RD WOOLWICH RD
 BERESFORD SQ BURRAGE RD

9
 ST GEORGES RD OLD KENT RD
 NEW F RD WOOLWICH RD
 B'SFORD SQ BURRAGE RD

10
 ABBEY RD ST JOHNSWOOD RD
 BAKER ST WIGMORE ST
 REGENT ST WHITEHALL

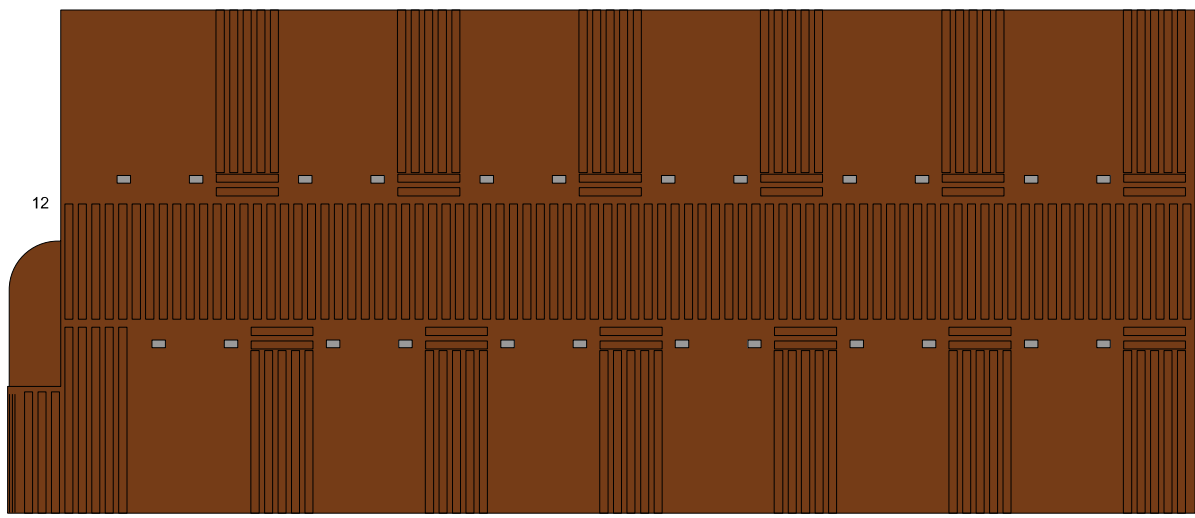
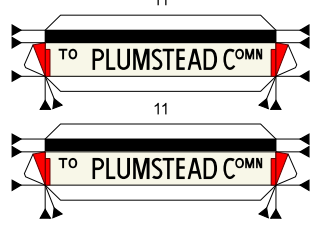

K-TYPE LONDON BUS 1:32
G: UPPER DECK

- G1 -

Alan Grayer 2020
 ktype@grayer.me.uk

HAIG WHISKY

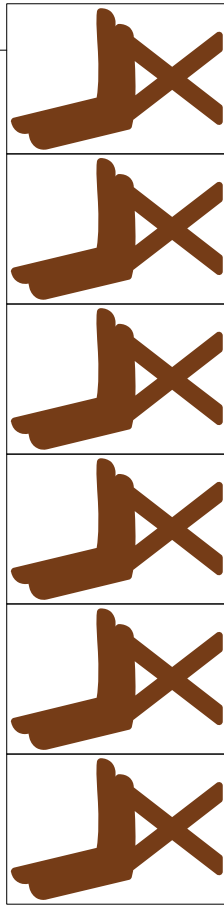
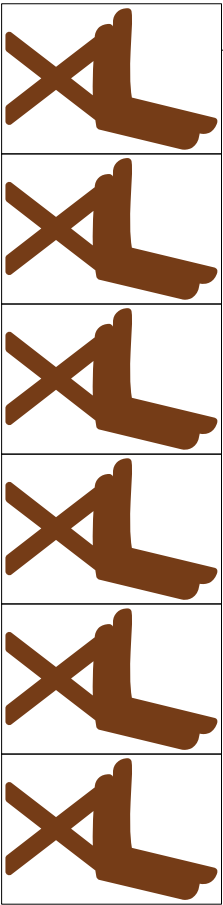
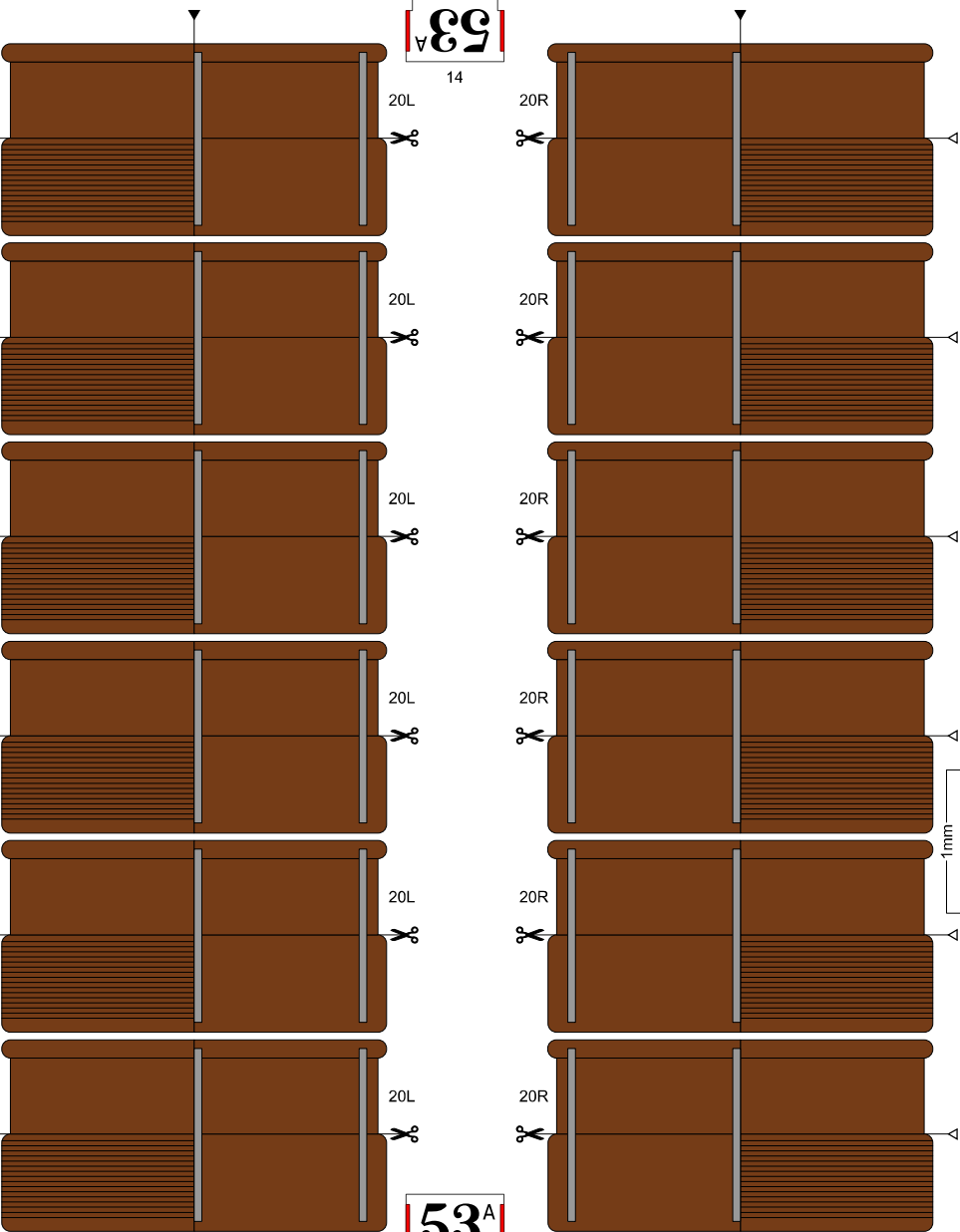
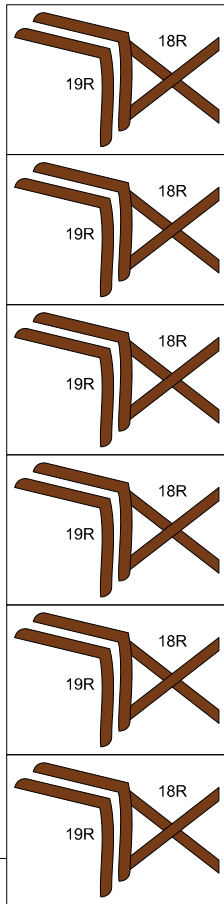
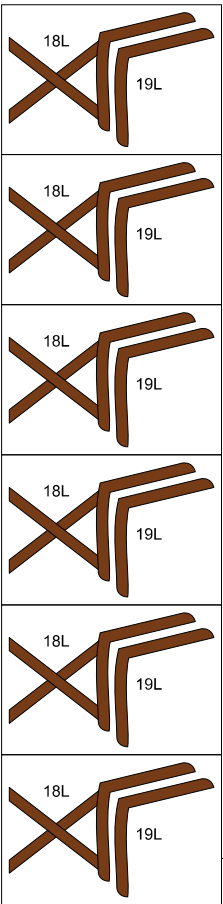

Schweppes TONIC WATER

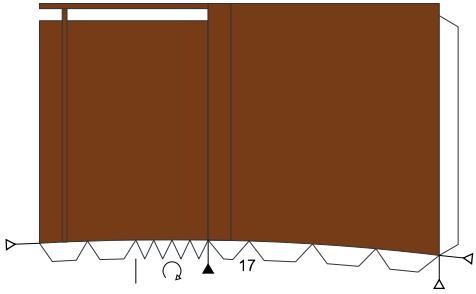
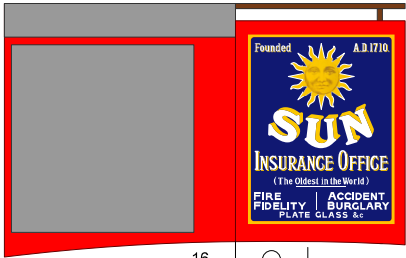

K-TYPE LONDON BUS 1:32
G: UPPER DECK

- G2 -

Alan Grayer 2020
ktype@grayer.me.uk

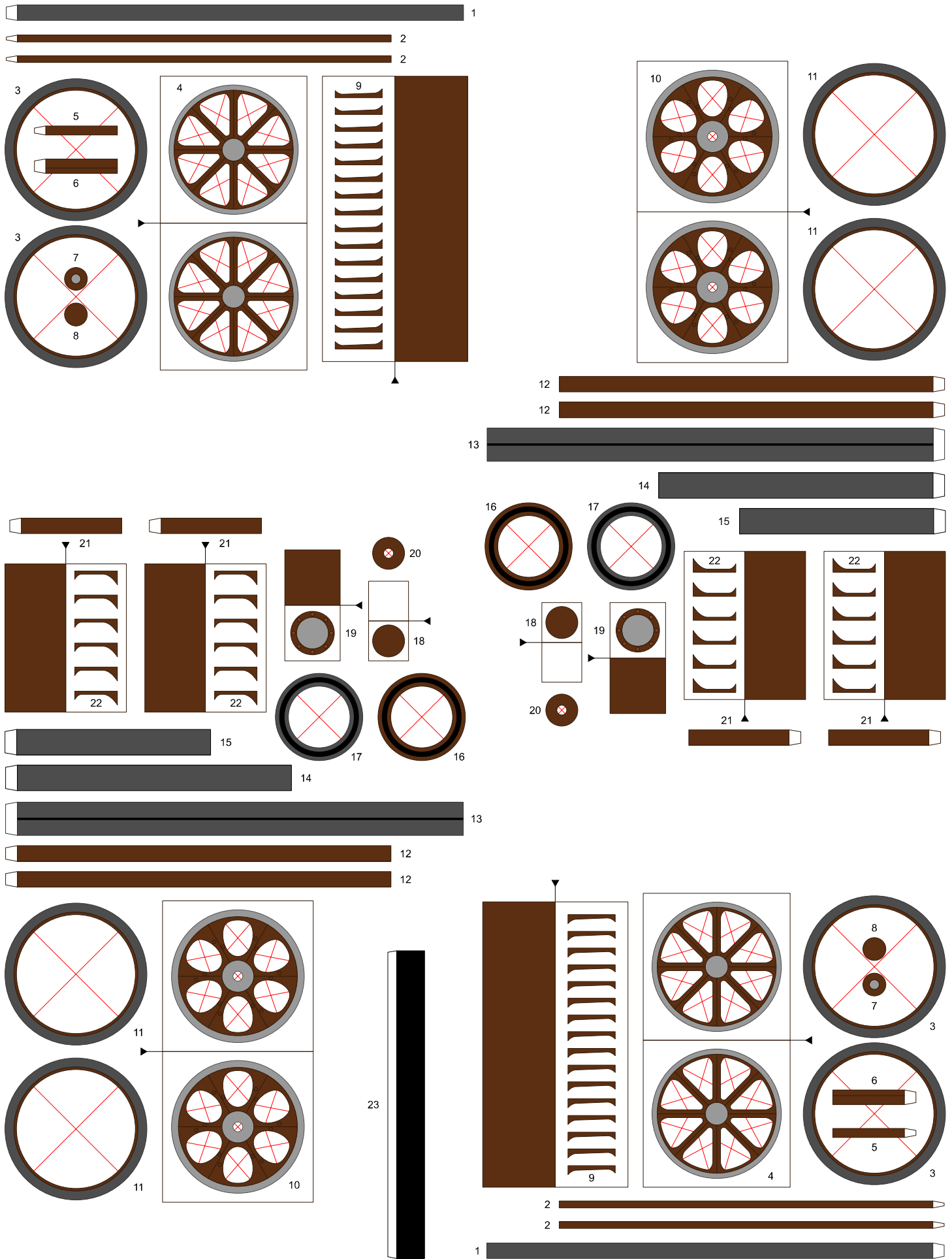

K-TYPE LONDON BUS 1:32
G: WHEELS

- G1 -

Alan Grayer 2020
 ktype@grayer.me.uk